



Price List 2024/25 by Trycare



NEW

Meet UniFit™ the ultimate implant, designed for simplicity and total success

UniFit is a variable-thread tapered implant with a spiral tap that ensures immediate stability through bone condensation during implant placement.

- Variable threads and a tapered design allows for accurate implant placement, for self-tapping, and for improved aesthetics.
- Unique design also ensures better load distribution, allowing for immediate function on all bone types.

UniFit features Adin's OsseoFix™, a unique Calcium Phosphate blast surface treatment that enhances the implant's integration with the bone. Experience immediate stability, improved accuracy, and better load distribution with UniFit Spiral Implant featuring Adin's OsseoFix™.

Built-In Platform
Switching

Back
tapered collar

Micro Threads:
Engineered to enhance bone
regeneration, prevent bone
loss & increase bone implant
contact

Minimally
invasive surgery

OsseoFix™ surface

Bone - condensing property
Self - drilling

Rounded apex

Seven degree
unified conical connection
Six position star index

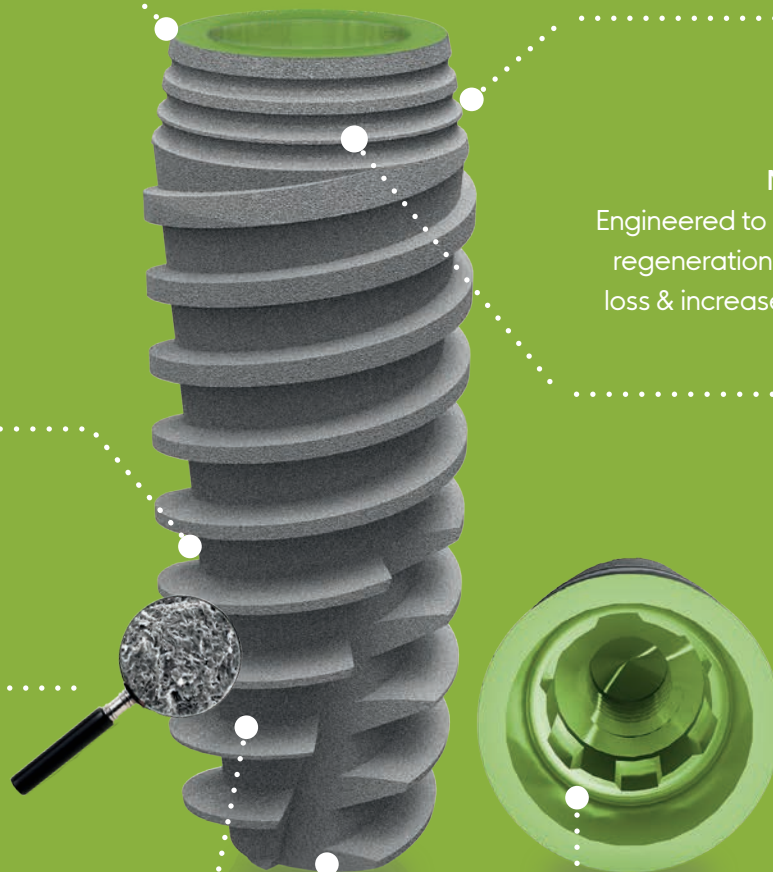

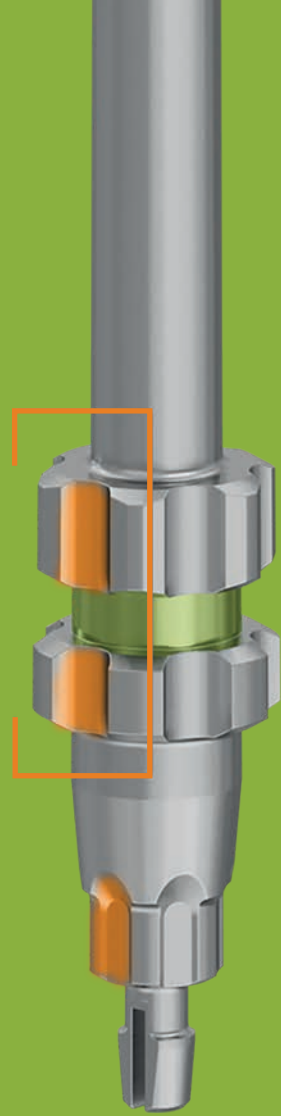

UniFit™ Brochure - Unified Conical Connection Implants

- scan the QR code or visit www.adin-implants.com/catalog-brochures/

Expertise

Adin's high-quality products, combine innovation with reliability and ease of use, they are designed to meet your professional requirements and your patients' needs.

With Adin, you have peace of mind.

Rewarding

Adin is focused on offering affordable solutions for patients and profitable solutions for dental professionals, without compromising on quality.

Recognition

Adin takes your success personally and are dedicated to serving your needs. We take pride in solving your challenges and devising innovative solutions. We're here for you, providing unmatched personal attention and exceptional service.





Table of Contents

The CloseFit™ System

Implant Lengths & Diameters -----	8
Abutments, Transfers & Copings -----	9
Snap-on Iris™ Impression & Restoration -----	10 - 11
Abutments, Drivers & Screws -----	12 - 14
Single TMA / TMA Components & Tools -----	15 - 17
Surgical Kits & Additional Tools -----	18 - 20
CAD-CAM Components -----	21
Guided Surgery Kits & Additional Tools -----	22 - 26
Torque Guide for Abutment / Prosthetic Systems -----	52
Implant Settings For Motor - CloseFit™ -----	54

The Touareg™ S System

Implant Lengths & Diameters -----	28
Abutments, Transfers & Copings -----	29
Snap-on Iris™ Impression & Restoration -----	30 - 31
Abutments, Drivers & Screws -----	32 - 34
Single TMA / TMA Components & Tools -----	35 - 37
Surgical Kits & Additional Tools -----	38 - 40
CAD-CAM Components -----	41
Guided Surgery Kits & Additional Tools -----	42 - 46
Torque Guide for Abutment / Prosthetic Systems -----	52
Implant Settings For Motor - Touareg™ S -----	55

○ CAD-CAM Basic Information -----	47
○ Drills & Stops Surgical Drills - Tri-Step & Twist Step -----	48 - 49
○ Drills & Stops Drills & Depth Stop Kits -----	50
○ Drills & Stops Drill Sequence -----	51
○  Kerator Overdenture Attachment System -----	56 - 57
○ Literature Downloads -----	58 - 59



CloseFit™ Thread with Conical Hex Connection

Three restorative platform
diameters and four
implant diameters

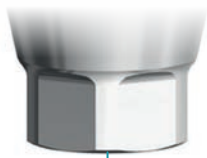

Conical hex connection

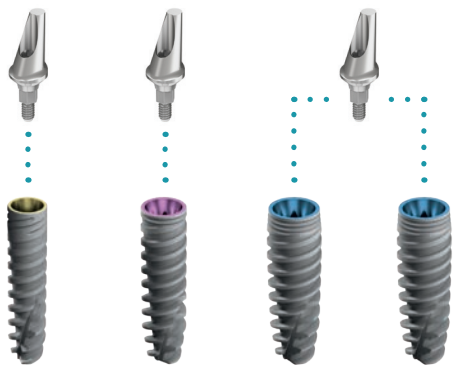
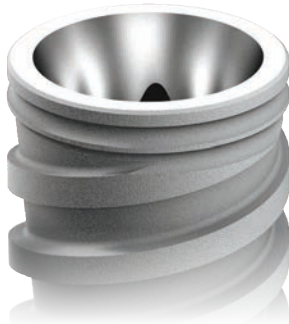

NP

3.00mm
Diameter

RP

3.50mm
Diameter

WP

4.30mm
Diameter

WP

5.00mm
Diameter



Touareg™ S Active Thread with Internal Hex Connection

Single restorative
platform diameter for
all implant diameters

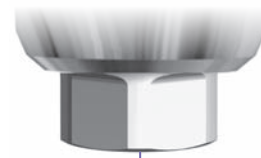

Standard internal hex

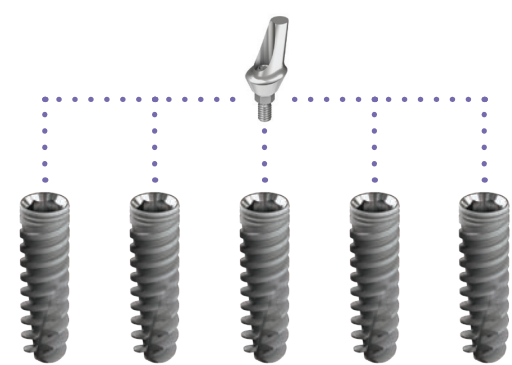
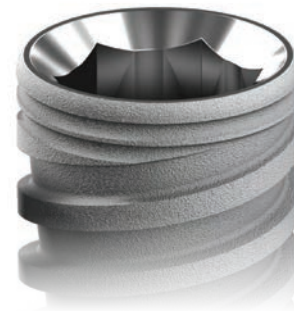

S

3.50mm
Diameter

S

3.75mm
Diameter

S

4.20mm
Diameter

S

5.00mm
Diameter

S

6.00mm
Diameter



CloseFit™

Conical Hex connection

Implant Lengths & Diameters	8
Abutments, Transfers & Copings	9
Snap-on Iris™ Impression & Restoration	10 - 11
Abutments, Drivers & Screws	12 - 13
TMA Components & Tools	15
Surgical Kits & Additional Tools	16 - 18
CAD-CAM Components	19
Guided Surgery Kits & Additional Tools	20 - 24
Implant Settings For Motor	50

..... **£125.00** per implant

The CloseFit™ System

CloseFit™ Spiral Implant System offers a unique, strong and solid conical-hex connection. This strong connection minimises micro movements between the implant and abutment, therefore minimising undesired crestal bone loss.

The CloseFit's tapered core implant includes a multi lead active and dynamic thread design. The unique design of the implant is suited for optimal repositioning at diverse angles within the lower and upper jaw. Designed for Subcrestal placement up to 1.0 - 2.0mm.

The CloseFit™ implants feature Adin's OsseoFix™- A biocompatible surface treatment that uses gritting with Calcium Phosphate media that is debris free and has been designed to achieve the desired roughness levels needed for optimal osseointegration.



CloseFit™ Implants

£125.00



NP

3.00mm
Diameter

Length	8mm	10mm	11.5mm	13mm	16mm	18mm
Mounted	n/a	ISPNP1030	ISPNP1130	ISPNP1330	ISPNP1630	ISPNP1830
Unmounted	n/a	UISPNP1030	UISPNP1130	UISPNP1330	UISPNP1630	UISPNP1830



RP

3.50mm
Diameter

Length	8mm	10mm	11.5mm	13mm	16mm	18mm
Mounted	ISPX0835	ISPX1035	ISPX1135	ISPX1335	ISPX1535	ISPX1835
Unmounted	UISPX0835	UISPX1035	UISPX1135	UISPX1335	UISPX1535	UISPX1835



WP

4.30mm
Diameter

Length	8mm	10mm	11.5mm	13mm	16mm	18mm
Mounted	ISPX0843	ISPX1043	ISPX1143	ISPX1343	ISPX1543	ISPX1843
Unmounted	UISPX0843	UISPX1043	UISPX1143	UISPX1343	UISPX1543	UISPX1843



WP

5.00mm
Diameter

Length	8mm	10mm	11.5mm	13mm	16mm	18mm
Mounted	ISPX0849	ISPX1049	ISPX1149	ISPX1349	ISPX1549	ISPX1849
Unmounted	UISPX0849	UISPX1049	UISPX1149	UISPX1349	UISPX1549	UISPX1849

CloseFit implants are available in Unmounted without an implant carrier or a Mounted implant presented on an implant carrier.

The mount should only be used to position the implant into the osteotomy and screw in a few turns, until secure in the bone. The carrier should then be removed by directly pulling back and switch to a surgical driver to fully seat the implant.

Abutments, Transfers & Copings

∅ = Diameter GH = Gingival Height RH = Restoration Height



















Healing Abutments £24.00

Slim	NP	RP	WP	GH
	NP0046	RP0046	WP0046	2mm
	NP0047	RP0047	WP0047	3mm
	NP0048	RP0048	WP0048	4mm
	NP0049	RP0049	WP0049	5mm
	NP0050	RP0050	WP0050	6mm
Wide	NP	RP	WP	GH
	NP0004	RP0022	WP0022	2mm
	NP0008	RP0023	WP0023	3mm
	NP0009	RP0024	WP0024	4mm
	NP0012	RP0025	WP0025	5mm
	NP0013	RP0026	WP0026	6mm
Anatomical	NP	RP	WP	GH
	NP0090	RP0090	WP0090	2mm
	NP0091	RP0091	WP0091	3mm
	NP0092	RP0092	WP0092	4mm
	NP0093	RP0093	WP0093	5mm
	NP0094	RP0094	WP0094	6mm

Temporary Abutments £30.00

	NP	RP	WP	
	NP0043 ∅ 3.7mm RH 8.0mm	RP0043 ∅ 3.7mm RH 8.8mm	WP0043 ∅ 4.2mm RH 9.4mm	with hex
	NP0044 ∅ 3.7mm RH 8.0mm	RP0044 ∅ 3.7mm RH 9.4mm	WP0044 ∅ 4.2mm RH 9.4mm	no hex
	TMA Temporary Copying		RS4900	£37.00

Transfers / Impression Copings £35.00

Fixture Level		NP	∅	Length
	Slim Open Tray	NP5614	3.2mm	14mm
	Open Tray	NP5514	4.2mm	14mm
	Slim Closed Tray	NP5113	3.2mm	13mm
	Closed Tray	NP5213	4.2mm	13mm
Fixture Level		RP	∅	Length
	Slim Open Tray	RP5610	3.6mm	10mm
	Slim Open Tray	RP5614	3.6mm	14mm
	Open Tray	RP5510	4.2mm	9mm
	Open Tray	RP5514	4.2mm	13mm
	Slim Closed Tray	RP5109	3.6mm	9mm
	Slim Closed Tray	RP5113	3.6mm	13mm
	Closed Tray	RP5209	4.2mm	9mm
	Closed Tray	RP5213	4.2mm	13mm
Fixture Level		WP	∅	Length
	Slim Open Tray	WP5610	4.0mm	10mm
	Slim Open Tray	WP5614	4.0mm	14mm
	Open Tray	WP5510	5.2mm	10mm
	Open Tray	WP5514	5.2mm	14mm
	Wide Open Tray	WP5410	6.0mm	10mm
	Wide Open Tray	WP5414	6.0mm	14mm
	Slim Closed Tray	WP5109	4.0mm	9mm
	Slim Closed Tray	WP5113	4.0mm	13mm
	Closed Tray	WP5209	5.2mm	9mm
	Closed Tray	WP5213	5.2mm	13mm
	Wide Closed Tray	WP5309	6.0mm	9mm
	Wide Closed Tray	WP5313	6.0mm	13mm

Snap-on Iris™

Adin's Snap-on impression is an effective and easy option for both implant level and abutment level impression copying. Plastic pickup cap placed over a precision machined abutment allows for accurate coping utilising closed tray impression.

Adin's Snap-on range aims to allow flexibility by offering various options to match users preferred method of use through pre packed kits.

Snap-on
Impression Coping

Snap-on
engagement

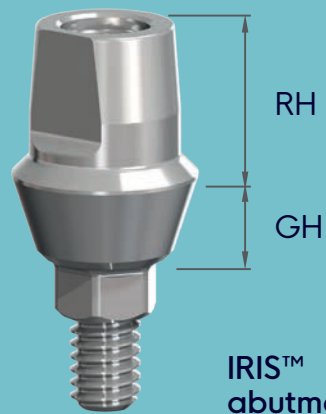
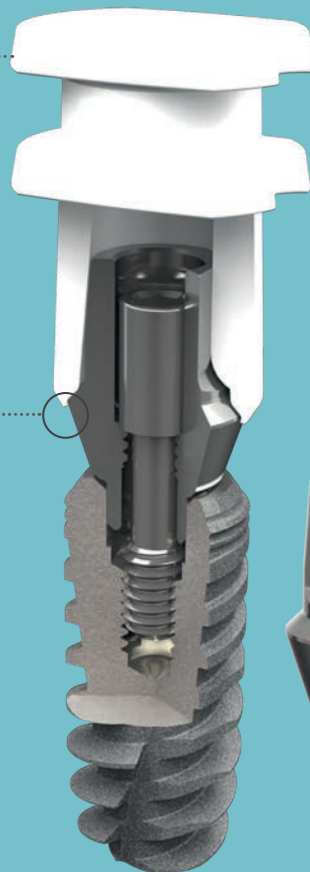

IRIS™
abutment



Snap-on Impression Kit includes:

1 x IRIS™ Abutment | 1 x Snap-on Cap | 1 x Implant Analog

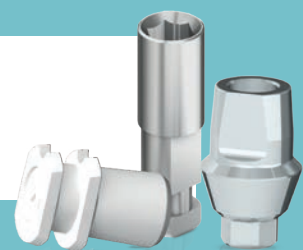

Snap-on Impression Kit for CloseFit™ Implants

The Snap-on impression kit is an easy to use implant level closed tray coping option. The variety in abutment transfer heights allows the taking of accurate impression in situations when other impression options do not.



CloseFit™				£30.00	
NP	RP	WP		RH	GH
IR2141	IR3141	IR5141	CloseFit Snap-on Impression Kit	4	1
IR2142	IR3142	IR5142	CloseFit Snap-on Impression Kit	4	2
IR2143	IR3143	IR5143	CloseFit Snap-on Impression Kit	4	3
IR2144	IR3144	IR5144	CloseFit Snap-on Impression Kit	4	4

Single item range for CloseFit™ Implants

Understanding that set procedures are not for everyone and in an effort to allow for full flexibility for Adin users, items are also available in single form.

Abutment Replica £24.00

			RH
	IR0404	IRIS Abutment Replica	4
	IR0406	IRIS Abutment Replica	6
	IR0408	IRIS Abutment Replica	8

Comfort Cap £16.00

			RH
	IR0180	IRIS PEEK Comfort Cap	4
	IR0181	IRIS PEEK Comfort Cap	6
	IR0089	IRIS PEEK Comfort Cap	8

Burnout Sleeves £24.00

	IR0182	IRIS Burnout Anti-rotation Cap, Red
	IR0183	IRIS Burnout Free-rotation Cap, White

Snap-on Impression Cap £40.00

	IR0179	IRIS Impression Coping
---	--------	------------------------

Transfers / Impression Copings £44.00

Abutment Level	NP	RP	WP
	TMA Open Tray Transfer Ø 4.9mm RH 11mm		RS5006
	TMA Closed Tray Transfer		RS5011

Screw / Casting Abutments

	NP	RP	WP
--	----	----	----

Plastic/Cobalt Chrome Engaging £56.90

	NP3094 Ø 10mm RH 4.2mm	RP3094 Ø 10mm RH 4.7mm	WP3094 Ø 10mm RH 5.2mm
---	------------------------------	------------------------------	------------------------------

Plastic/Cobalt Chrome Non Engaging £56.90

	NP3100 Ø 10mm RH 4.2mm	RP3100 Ø 10mm RH 4.7mm	WP3100 Ø 10mm RH 5.2mm
---	------------------------------	------------------------------	------------------------------

All Plastic Engaging £30.00

	NP0045 Ø 9mm RH 3.5mm	RP0045 Ø 9mm RH 3.7mm	WP0045 Ø 19mm RH 4.2mm
---	-----------------------------	-----------------------------	------------------------------

TMA Plastic Casting Sleeve £26.00

	Ø 4.85mm RH 12mm	RS5001
---	------------------	--------

Plastic/Titanium Collar Engaging ⓘ £37.00

	NP3095 Ø 10mm RH 4.2mm	RP3095 Ø 10mm RH 4.7mm	WP3095 Ø 10mm RH 5.2mm
---	------------------------------	------------------------------	------------------------------

Plastic/Titanium Collar Non Engaging ⓘ £37.00

	NP3097 Ø 10mm RH 4.2mm	RP3097 Ø 10mm RH 4.7mm	WP3097 Ø 10mm RH 5.2mm
---	------------------------------	------------------------------	------------------------------

NOTE

Plastic Titanium casting abutments require special instruction for use. Literature on melting points and metal to use available upon request.

Cement Abutments Angulated £46.00

	NP	RP	WP
--	----	----	----

Angulated 15° - 1mm Shoulder

	NP0015 Ø 4.8mm RH 6.5mm	RP0013 Ø 4.4mm RH 6.5mm	WP0013 Ø 5.0mm RH 6.5mm
---	-------------------------------	-------------------------------	-------------------------------

Angulated 15° - 2mm Shoulder

	NP0026 Ø 4.8mm RH 6.5mm	RP0014 Ø 4.4mm RH 6.5mm	WP0014 Ø 5.0mm RH 6.5mm
---	-------------------------------	-------------------------------	-------------------------------

Angulated 15° - 3mm Shoulder

	NP0063 Ø 4.8mm RH 6.5mm	RP0015 Ø 4.4mm RH 6.5mm	WP0015 Ø 5.0mm RH 6.5mm
---	-------------------------------	-------------------------------	-------------------------------

Angulated 15° - Slim No Shoulder

	Ø 4.00mm RH 8mm	NP0018
---	-----------------	--------

Cement Abutments Straight £37.00

	NP	RP	WP
--	----	----	----

Straight - 1mm Shoulder

	NP0019 Ø 4.4mm RH 6.5mm	RP0012 Ø 4.4mm RH 6.5mm	WP0012 Ø 5.0mm RH 6.5mm
---	-------------------------------	-------------------------------	-------------------------------

Straight - 2mm Shoulder

	NP0011 Ø 4.4mm RH 6.5mm	RP0011 Ø 4.4mm RH 6.5mm	WP0011 Ø 5.0mm RH 6.5mm
---	-------------------------------	-------------------------------	-------------------------------

Straight - 3mm Shoulder

	NP0064 Ø 4.8mm RH 6.5mm	RP0010 Ø 4.4mm RH 6.5mm	WP0010 Ø 5.0mm RH 6.5mm
---	-------------------------------	-------------------------------	-------------------------------

Slim - No Shoulder

	NP0010 Ø 3.5mm RH 6.0mm	RP0020 Ø 4.0mm RH 6.0mm	WP0020 Ø 4.2mm RH 6.0mm
---	-------------------------------	-------------------------------	-------------------------------

∅ = Diameter GH = Gingival Height RH = Restoration Height

Ball Abutments £40.00

Ball Diameter	NP	RP	WP	
2.5mm	∅ 2.39mm RH 2.45mm	∅ 3.1mm RH 2.72mm	∅ 3.5mm RH 2.72mm	
	NP0020	RP0051	WP0051	0.5mm
	NP0021	RP0052	WP0052	1.0mm
	NP0022	RP0053	WP0053	2.0mm
	NP0023	RP0054	WP0054	3.0mm
	NP0024	RP0055	WP0055	4.0mm
	N/A	RP0056	WP0056	5.0mm

IMPORTANT

The Restorative Torque Driver RS6090 is needed to fit all ball attachments (page 14). This driver is not included in any surgical kits. When ordering ball abutments you will also need to order ball attachment caps and inserts featured below.



Ball Abutment Caps & Inserts



	Plastic Insert White Hard	RS2660	£10.00
	Plastic Insert Pink Soft	RS2662	£10.00
	Titanium Ball Keeper	RS2670	£37.00

Implant Analogues

	NP	RP	WP	
	NP0007	RP0007	WP0007	£23.00
	Ball Abutment	RS5740		£20.00
	TMA Abutment Analogue	RS5004		£24.00

Surgical Drivers £54.00

For use with mounted and unmounted implants

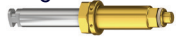
Implant	NP	RP	WP	Hex
Short 	NP0068	RP0068	WP0068	2mm
Medium 	NP0071	RP0071	WP0071	2.25mm
Long 	NP0074	RP0074	WP0074	2.65mm



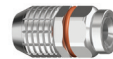

Adapters £57.60

Converts Surgical Implant Drivers above to Torque Driver Tip







Wrench Ratchet Surgical Instrument Handle RA0050

Restorative Hand Drivers £54.00

	NP	RP	WP	Tip Type
		RP0004		Star Long 14mm
		RP0064		Star Short 8mm
		RS6191		TMA/FC Long Female Hex
		RS6193		TMA/FC Short Female Hex

Restorative RA Drivers £54.00

	NP	RP	WP	Tip Type
		RP0019		Star Long 17mm
		RP0018		Star Short 12mm
		RS6195		TMA/FC Long
		RS6194		TMA/FC Short

Restorative Torque Drivers

£54.00

	NP	RP	WP	Tip Type
		RP0005		Star Long 14mm
		RP0065		Star Short 9mm
		RS6090		Ball Attachments
		RS6196		TMA/FC Short Hex
		RS6197		TMA/FC Long Hex



Screws Abutment

£7.00

	NP	RP	WP
	NP0001	RP0001	WP0001

Screws TMA

£10.50

	NP	RP	WP	Length
	NP0039	RP0039	WP3406	1.0mm
	NP0040	RP0040	WP3407	2.0mm
	NP0041	RP0041	WP3408	3.0mm
	NP3409	RP3409	WP3409	4.0mm
	NP3412	RP3412	WP3412	5.0mm
	NP0042	RP3403	WP3403	Angled
	TMA Prosthetic		RS3404	£7.00

Accuracy & flexibility for single tooth restoration

STMA offers the possibility to combine the benefits of transgingival approach and screw-retained single tooth restoration yielding greater flexibility in both esthetics, safety and restoration maintenance.

Based on the TMA abutment, with the added hex index offers both the required accurate positioning and retention to support a single tooth crown. Open and closed tray transfers as well as scan bodies for digital impression are available to match every preferred impression method as well as replicas for straight forward and simple work processes.

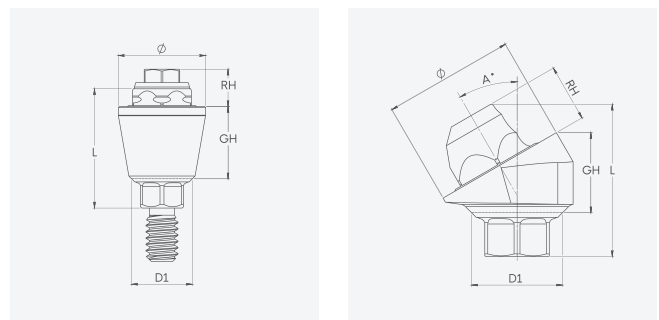

TMA Straight Single

£49.00

NP		L	D1	Ø	GH	RH
NP0032S	STMA Abutment 1mm	4.2	2.5	4.9	1.0	2.1
NP0033S	STMA Abutment 2mm	5.2	2.5	4.9	2.0	2.1
NP0034S	STMA Abutment 3mm	6.2	2.5	4.9	3.0	2.1
NP3729S	STMA Abutment 4mm	7.2	2.5	4.9	4.0	2.1
NP3730S	STMA Abutment 5mm	8.2	2.5	4.9	5.0	2.1
RP		L	D1	Ø	GH	RH
RP0032S	STMA Abutment 1mm	4.2	2.9	4.9	1.0	2.1
RP0033S	STMA Abutment 2mm	5.2	2.9	4.9	2.0	2.1
RP0034S	STMA Abutment 3mm	6.2	2.9	4.9	3.0	2.1
RP3729S	STMA Abutment 4mm	7.2	2.9	4.9	4.0	2.1
RP3730S	STMA Abutment 5mm	8.2	2.9	4.9	5.0	2.1
WP		L	D1	Ø	GH	RH
WP3731S	STMA Abutment 1mm	4.3	3.35	4.9	1.0	2.1
WP3732S	STMA Abutment 2mm	5.3	3.35	4.9	2.0	2.1
WP3733S	STMA Abutment 3mm	6.3	3.35	4.9	3.0	2.1
WP3729S	STMA Abutment 4mm	7.3	3.35	4.9	4.0	2.1
WP3730S	STMA Abutment 5mm	8.3	3.35	4.9	5.0	2.1



TMA Angled Single

£83.00

NP		L	D1	Ø	GH	RH
NP0035S	STMA Abutment 17° 3mm	6.6	2.5	4.9	2.8	2.15
NP0036S	STMA Abutment 30° 3.5mm	6.7	2.5	4.9	3.5	2.15
NP0037S	STMA Abutment 30° 5mm	8.1	2.5	4.9	4.9	2.15
NP0038S	STMA Abutment 17° 4mm	7.7	2.5	4.9	3.9	2.15
RP		L	D1	Ø	GH	RH
RP3734S	STMA Abutment 17° 2.5mm	6.4	2.9	4.9	2.6	2.15
RP3735S	STMA Abutment 30° 3mm	6.9	2.9	4.9	3.7	2.15
RP3737S	STMA Abutment 17° 3.5mm	7.5	2.9	4.9	3.7	2.15
RP3738S	STMA Abutment 30° 4mm	7.3	2.9	4.9	4.0	2.15
WP		L	D1	Ø	GH	RH
WP3734S	STMA Abutment 17° 2.5mm	6.4	3.35	4.9	2.5	2.15
WP3735S	STMA Abutment 30° 3mm	6.8	3.35	4.9	3.5	2.15
WP3737S	STMA Abutment 17° 3.5mm	7.4	3.35	4.9	3.5	2.15
WP3738S	STMA Abutment 30° 4mm	7.5	3.35	4.9	4.1	2.15

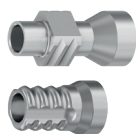
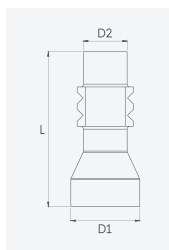
**Transfers**

		L	D1	D2	
RS5006S	Single TMA Open Tray Transfer	11.0	4.9	3.1	£49.00
RS5011S	Single TMA Closed Tray Transfer	8.0	4.9	4.1	£44.50

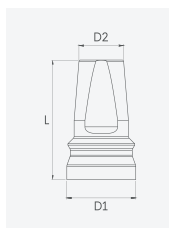
**Snap-On**

		L	D1	D2	
IR0179	IRIS™, Impression coping				£40.00
RS5012S	Single TMA Snap-On Transfer	8.0	4.9	3.2	£49.00

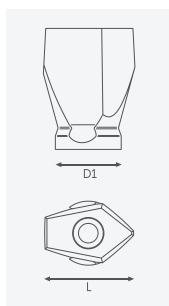
**Scan Body**

		L	D1	
TM0006S	Single TMA Scan Body	6.0	4.9	£40.50
TM0009S		9.0	4.9	£40.50

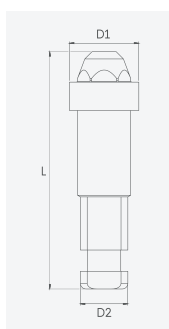
**STMA Replica**

		L	D1	
RS5004S	STMA Abutment Replica	16.75	4.9	£24.10

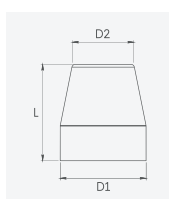
**Healing Cap**

		L	D1	D2	
RS5005S	Single TMA Healing Cap	5.5	4.9	3.5	£24.10

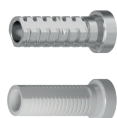
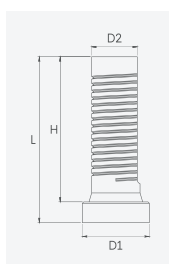
**STMA Prosthetic**

		L	D1	D2	H	
RS4900S	Single TMA Titanium Temporary	12.0	4.9	3.5	10.5	£37.00
RS5001S	Single TMA Plastic Casting Sleeve with Prosthetic Screw	12.0	4.9	3.5	10.35	£26.00

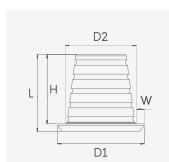
**STMA Prosthetic**

		L	D1	D2	H	W	
TM0011S	Single TMA Cementing Cone, Low profile	4.9	5.5	4.5	4.4	0.5	£38.10







TMA Multi-Unit Abutments

Trans Mucosal Abutments to facilitate All-on-4 and All-on-6 implant restorations.

Replacement screws for components are available.

TMA Screw Retained Straight £49.00

	NP	RP	WP	GH
	Ø 4.9mm RH 1.0mm	Ø 4.9mm RH 1.0mm	Ø 4.9mm RH 1.0mm	
	NP0032	RP0032	WP3731	1.0mm
	NP0033	RP0033	WP3732	2.0mm
	NP0034	RP0034	WP3733	3.0mm
	NP3729	RP3729	WP3729	4.0mm
	NP3730	RP3730	WP3730	5.0mm



TMA Screw Retained Angled £79.00

	NP	RP	WP	GH
	Ø 4.9mm RH 2.15mm	Ø 4.9mm RH 2.15mm	Ø 4.9mm RH 2.15mm	
	17° NP0035	RP3734	WP3734	NP 3mm RP/WP 2.5mm
	30° NP0036	N/A	N/A	3.5mm
	30° N/A	RP3735	WP3735	3.5mm
	30° NP0037	N/A	N/A	5.0mm
	30° N/A	RP3738	WP3738	4.5mm
	17° NP0038	RP3737	WP3737	NP 4mm RP/WP 3.5mm



TMA Accessories

	RS4900	Temporary Copying Ø 4.85mm RH 12mm	£37.00
	RS5001	Plastic Casting Sleeve Ø 4.85mm RH 12mm	£26.00
	RS5004	Abutment Analogue	£24.00
	RS5005	Healing Cap	£24.00
	RS5006	Open Tray Transfer Ø 4.9mm RH 11mm	£44.00
	RS5011	Closed Tray Transfer	£44.00



TMA Hand Drivers £54.00

	NP	RP	WP
		RS6191	Female Long Hex
		RS6193	Female Short Hex

TMA Torque Drivers £54.00

	NP	RP	WP
		RS6196	TMA/FC Hex Long
		RS6197	TMA/FC Hex Short

TMA RA Drivers £54.00

	NP	RP	WP
		RS6195	TMA/FC Hex Long
		RS6194	TMA/FC Hex Short

NOTE

Use TMA Drivers for Straight TMA Abutments, and a Hex 1.27 Driver for Angled TMA Abutments [RS6082]



Premium Surgical Kit

CF6300

£1,500.00

Drills

Tip Drill	RS8032
Tri-Step Drill - Long	TD2218
Pilot Drill 2mmD x 8 - 18mmL	DL1820
Twist Step Drill 1.8 / 2.5mmD x 8 - 18mmL	DL1825
Twist Step Drill 2.3 / 2.8mmD x 8 - 18mmL	DL1828
Twist Step Drill 2.8 / 3.2mmD x 8 - 18mmL	DL1832
Twist Step Drill 3.2 / 3.6mmD x 8 - 18mmL	DL1836
Twist Step Drill 3.8 / 4.2mmD x 8 - 18mmL	DL1842
Twist Step Drill 4.2 / 4.6mmD x 8 - 18mmL	DL1846
Tri-Step Drill - Short	TD1511
Pilot Drill 2mmD x 6 - 13mmL	DL1320
Twist Step Drill 1.8 / 2.5mmD x 6 - 13mmL*	DL1325
Twist Step Drill 2.3 / 2.8mmD x 6 - 13mmL	DL1325
Twist Step Drill 2.8 / 3.2mmD x 6 - 13mmL	DL1332
Twist Step Drill 3.2 / 3.6mmD x 6 - 13mmL	DL1336
Twist Step Drill 3.8 / 4.2mmD x 6 - 13mmL	DL1342
Twist Step Drill 4.2 / 4.6mmD x 6 - 13mmL	DL1346

Surgical Tools

Wrench Ratchet Surgical Instruments Handle	RA0050
Surgical Torque Ratchet 35 - 100 Ncm	RS6111
Depth Probe	RS6180

Parallel Pins

Parallel Pin Short 11mm (qty. 4)	RS6150
Parallel Pin Long 16mm (qty. 2)	RS6155

Insertion Tools

NP 2mm Hex Handpiece Adapter - Short	NP0068
NP 2mm Hex Handpiece Adapter - Medium	NP0071
NP 2mm Hex Handpiece Adapter - Long	NP0074
RP 2.25mm Hex Handpiece Adapter - Short	RP0068
RP 2.25mm Hex Handpiece Adapter - Medium	RP0071
RP 2.25mm Hex Handpiece Adapter - Long	RP0074
WP 2.65mm Hex Handpiece Adapter - Short	WP0068
WP 2.65mm Hex Handpiece Adapter - Medium	WP0071
WP 2.65mm Hex Handpiece Adapter - Long	WP0074

Drivers

Star Hand Driver - Short	RP0064
Star Hand Driver - Long	RP0004

Drill Extension

Drill Extension	RS9027
-----------------	--------

*Products may be ordered separately as an addition to the kit

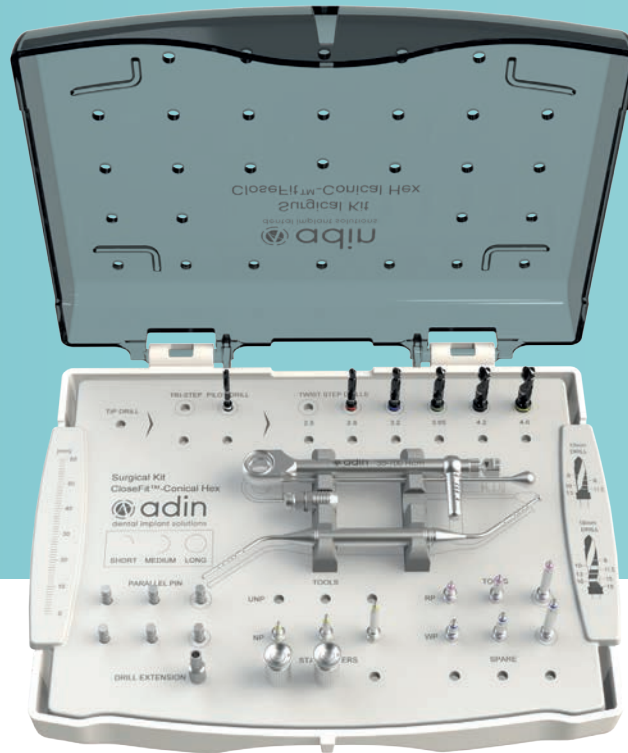

Advanced Surgical Kit CF6302 £950.00

Drills

Pilot Drill 2mmD x 8 - 18mmL	DL1820
Twist Step Drill 2.3 / 2.8mmD x 8 - 18mmL	DL1828
Twist Step Drill 2.8 / 3.2mmD x 8 - 18mmL	DL1832
Twist Step Drill 3.2 / 3.6mmD x 8 - 18mmL	DL1836
Twist Step Drill 3.6 / 4.2mmD x 8 - 18mmL	DL1842
Twist Step Drill 4.2 / 4.6mmD x 8 - 18mmL	DL1846

Surgical Tools

Wrench Ratchet Surgical Instruments Handle	RA0050
Surgical Torque Ratchet 35 - 100 Ncm	RS6111
Depth Probe	RS6180

Parallel Pins

Parallel Pin Short 11mm (qty. 4)	RS6150
Parallel Pin Long 16mm (qty. 2)	RS6155

Insertion Tools

NP 2mm Hex Handpiece Adapter - Short	NP0068
NP 2mm Hex Handpiece Adapter - Medium	NP0071
NP 2mm Hex Handpiece Adapter - Long	NP0074
RP 2.25mm Hex Handpiece Adapter - Short	RP0068
RP 2.25mm Hex Handpiece Adapter - Medium	RP0071
RP 2.25mm Hex Handpiece Adapter - Long	RP0071
WP 2.65mm Hex Handpiece Adapter - Short	WP0068
WP 2.65mm Hex Handpiece Adapter - Medium	WP0071
WP 2.65mm Hex Handpiece Adapter - Long	WP0074

Drivers

Star Hand Driver - Short	RP0064
Star Hand Driver - Long	RP0004

Drill Extension

Drill Extension	RS9027
-----------------	--------

Trycare Basic Prosthetic Kit
£531.80

	RP0005	Restorative Torque Driver Star Long 14mm
	RP0065	Restorative Torque Driver Star Short 9mm
	RS6197	Restorative Torque Driver TMA/FC Hex Short
	RP0004	Restorative Hand Driver Star Long 14mm
	RP0064	Restorative Hand Driver Star Short 8mm
	RP0018	Restorative RA Driver Star Short 12mm

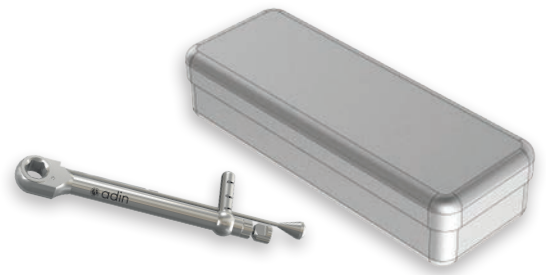

UNAB004	Aluminium Instrument Box Silver 10 x 3 x 2cm
RS6112	Prosthetic Torque Ratchet 15 - 35 Ncm



RS7001	Surgical Driver	£120.00
--------	-----------------	----------------



RS6111	Surgical Torque Ratchet 35 - 100 Ncm	£200.00
--------	--------------------------------------	----------------



RS6112	Prosthetic Torque Ratchet 15 - 35 Ncm	£200.00
--------	---------------------------------------	----------------



RS6100	Wrench Ratchet	£126.00
--------	----------------	----------------



RS6180	Depth Probe	£39.30
--------	-------------	---------------



RS6150	Parallel Pin 11	£30.00
--------	-----------------	---------------



RS6155	Parallel Pin 16	£30.00
--------	-----------------	---------------





RS8032	Tip Drill	£74.00
--------	-----------	---------------



RS9027	Drill Extender	£42.00
--------	----------------	---------------









Scanbody £43.00

	NP	RP	WP	
	NP0088	RP0088	WP0088	7mm
	NP0089	RP0089	WP0089	10mm



Scanbody TMA £36.00

	TM0006	6mm
	TM0009	9mm



Screws £7.00

	TM0001	TMA Scan Body
	RS3400	RS Prosthetic
	RS3425	RS Closed Tray Transfer
	RS3402	RS Short Prosthetic
	WP0001	WP Abutment
	RP0001	RP Abutment
	NP0001	NP Abutment

Ti Blanks £54.00

	NP	RP	WP	Ø
	NP1111	RP1211	WP1311	11.5mm
	NP1115	RP1215	WP1315	15.8mm

Ti Base £41.00

	NP	RP	WP	
	NP1004	RP1204	WP1304	Engaged
	NP1017	RP1217	WP1317	Angular Engaged 
	NP1008	RP1208	WP1308	Non Engaged

NOTE

The Screw Channel on the Angular Ti-Base is NOT angular and does NOT require an angled screwdriver.

TMA-MU

	TM0010	Cementing Cone	£34.00
	RS4900	TMA Temporary Copying	£37.00

Digital Model Analog £26.55

	WP1000	WP Digital Model Analog
	RP1000	RP Digital Model Analog
	NP1000	NP Digital Model Analog

Digital Model Analog TMA £30.60

	RS1001	Digital Model TMA Abutment Replica
---	--------	------------------------------------

CAD-CAM SOFTWARE

Scan the QR code to download the Adin CAD-CAM Software for digital libraries of Exocad, 3Shape and dental wings.



adinguide™

Take your practice to the next level

The adinguide™ was created with you in mind, bringing the guided surgery world to your clinic. The kits were specifically designed to support effortless procedures, accurate and predictable implant placement. The ActiveFlow™ Irrigation Technology is a unique design that forces coolant through the guide to ensure irrigation reaches the bone and prevents overheating.

The adinguide™ drills are designed with carved channels which allow saline coolant from your hand-piece to stream through the sleeve directly into the osteotomy site while drilling.

Our uniquely designed drill kit is intuitive and easy to use by implant diameter and length. The Tissue Punch and Pilot Drill allow for easy flapless access.

Keyless procedure enables easy handling and full visibility of surgical field.

Self-centering drills - controlled by a 5.5mm / 3.3 mm / 2.0 mm diameter cylinder at the top of each drill centers the drill in the guide's sleeve.

Self-centering cylinder - engages the sleeve before the drill engages the osteotomy in order to ensure correct positioning of the drill.

Built-in stoppers - ensure precise and accurate drilling to the desired depth.



Keyless Procedure

This innovative approach developed to support effortless procedures, accurate and predictable implant placement.



ActiveFlow™ Irrigation Technology

The adinguide™ ActiveFlow™ Irrigation Technology is a unique design that forces coolant through the guide and ensure that irrigation reaches the bone. Within each cylinder are unique channels which allow coolant to stream through the sleeve while drilling.

- ActiveFlow™ Technology - through the guide irrigation
- As the drill starts to spin, ActiveFlow™ starts operation
- Delivers the coolant from the hand - piece directly to the surgical site and may prevent bone heating

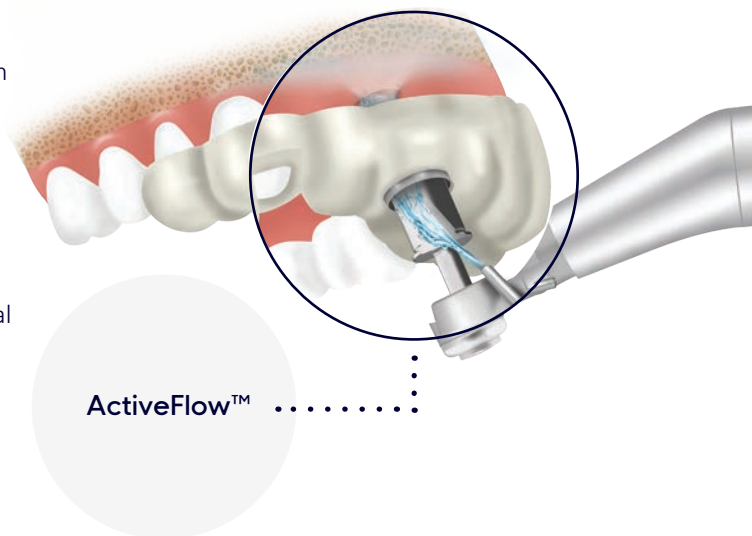

Self-Centering Drills & Tools

Adin's keyless, self-centering drills and tools are designed to enable dentists to perform faster, easier and more intuitive implant surgeries. Organised in a way that enhances safety and ease of use, Adin sleeves are embedded within the 3D printed surgical guide and precisely center and guide drills and insertion tools. Self-centering drills, controlled by a main diameter cylinder at the top of each drill, centers the drill in the guide's sleeve. The surgical guide and drilling procedure are designed so that the self-centering cylinder engages the sleeve before the drill touches the bone in order to ensure correct positioning of the drill.

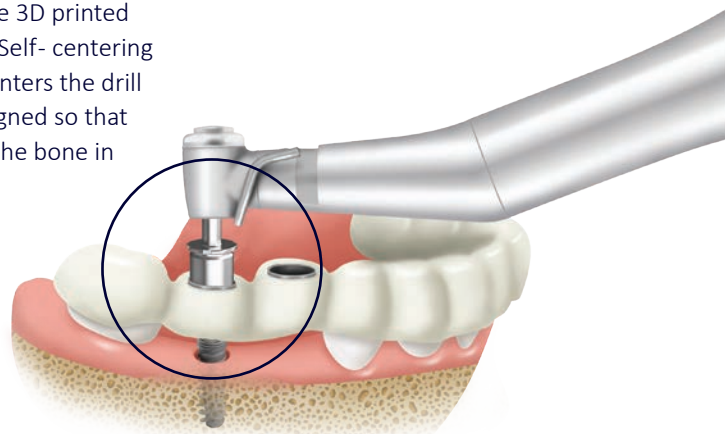



Buy both kits together

CloseFit™ RP/WP Implants Drill Kit

GSK001 £1,300.00

	Tissue Punch 5.0mmD, S-5.5	GS5055		Drill S-5.5, 3.85 / 3.2mmD x 6.25mmL	GS0638
	Pilot Drill S-5.5, 2.5 / 1.8mmD x 6.0mmL	GS0625		Drill S-5.5, 3.85 / 3.2mmD x 8.0mmL	GS0838
	Drill S-5.5, 2.5 / 1.8mmD x 8.0mmL	GS0825		Drill S-5.5, 3.85 / 3.2mmD x 10.0mmL	GS1038
	Drill S-5.5, 2.5 / 1.8mmD x 10.0mmL	GS1025		Drill S-5.5, 3.85 / 3.2mmD x 11.5mmL	GS1138
	Drill S-5.5, 2.5 / 1.8mmD x 11.5mmL	GS1125		Drill S-5.5, 3.85 / 3.2mmD x 13.0mmL	GS1338
	Drill S-5.5, 2.5 / 1.8mmD x 13.0mmL	GS1325		Drill S-5.5, 3.85 / 3.2mmD x 16.0mmL	GS1638
	Drill S-5.5, 2.5 / 1.8mmD x 16.0mmL	GS1625		Drill S-5.5, 4.6 / 3.85mmD x 6.25mmL	GS0646
	Drill S-5.5, 3.2 / 2.5mmD x 6.25mmL	GS0632		Drill S-5.5, 4.6 / 3.85mmD x 8.0mmL	GS0846
	Drill S-5.5, 3.2 / 2.5mmD x 8.0mmL	GS0832		Drill S-5.5, 4.6 / 3.85mmD x 10.0mmL	GS1046
	Drill S-5.5, 3.2 / 2.5mmD x 10.0mmL	GS1032		Drill S-5.5, 4.6 / 3.85mmD x 11.5mmL	GS1146
	Drill S-5.5, 3.2 / 2.5mmD x 11.5mmL	GS1132		Drill S-5.5, 4.6 / 3.85mmD x 13.0mmL	GS1346
	Drill S-5.5, 3.2 / 2.5mmD x 13.0mmL	GS1332		Drill S-5.5, 4.6 / 3.85mmD x 16.0mmL	GS1646
	Drill S-5.5, 3.2 / 2.5mmD x 16.0mmL	GS1632			

Separate kit required for NP Implants:

CloseFit™ NP Implants Drill & Tool Kit

GSK002 £1,300.00



for only
£1,995.00



CloseFit™ RP/WP Tool Kit

GSK004

£900.00

	Anchoring Drill S-2.0, 2.0 / 1.5mmD x 19mmL	GS1915		Manual Socket L 10.5	GS0023
	Anchoring Drill S-2.0, 2.0 / 1.7mmD x 19mmL	GS1917		Manual Socket L 14.5	GS0024
	Handpiece Guide Fixation Screw Driver	GS0028		Handpiece Socket L 10.5	GS0021
	Guided RP Handpiece Fixture Mount S-5.5	GS0041		Drill Extension	RS9027
	Guided RP Ratchet Fixture Mount S-5.5	GS0043		Star Hand Driver - Long	RP0004
	Guided RP Ratchet Fixture Mount S-5.5, Screw Retained	GS0037		Surgical Torque Ratchet 35 - 100 Ncm for hex 4mm	GS6111
	RP Ratchet Retrieval Tool	GS0046		Guide Fixation Screw Driver	GS0027
	Guided WP Handpiece Fixture Mount S-5.5	GS0042			
	Guided WP Ratchet Fixture Mount S-5.5	GS0044			
	Guided WP Ratchet Fixture Mount S-5.5, Screw Retained	GS0039			
	WP Ratchet Retrieval Tool	GS0047			

Separate kit required for NP Implants:

CloseFit™ NP Implants Drill & Tool Kit

GSK002

£1,300.00





Sleeves

£10.50

GS0055 5.5mmD Sleeve

GS0033 Narrow Implants 3.3mmD Sleeve

GS1920 2.0mmD Sleeve

Screws

£8.20

GS1920 2.0D 19mmL Anchorage Screw



GS0006 Vertical Fixation Screw S-3.3



GS0007 Vertical Fixation Screw S-5.5

Drills 18mm

£8.20

GS1825 Drill S-5.5, 2.5/1.8mmD x 18.0mmL

Drills Narrow Platform

£70.00

GSN0625 Pilot Drill S-3.3, 2.5/1.8mmD x 6.0mmL



GSN1025 Drill S-3.3, 2.5/1.8mmD x 10.0mmL



GSN1125 Drill S-3.3, 2.5/1.8mmD x 11.5mmL



GSN1325 Drill S-3.3, 2.5/1.8mmD x 13.0mmL



GSN1625 Drill S-3.3, 2.5/1.8mmD x 16.0mmL



GSN1825 Drill S-3.3, 2.5/1.8mmD x 18.0mmL

Tissue Punch

£59.50

GSN3033 Narrow Tissue Punch 3.0mmD, S-3.3





 **Touareg™ S**
Internal Hex RS

Implant Lengths & Diameters	26
Abutments, Transfers & Copings	27
Snap-on Iris™ Impression & Restoration	28 - 29
Abutments, Drivers & Screws	30 - 31
TMA Components & Tools	33
Surgical Kits & Additional Tools	34 - 36
CAD-CAM Components	37
Guided Surgery Kits & Additional Tools	38 - 42
Implant Settings For Motor	51

..... **£99.00** per implant

The Touareg™ S System

Touareg™ S Active Implant System is a tapered implant with a spiral tap which condenses bone for increased immediate stability. It has two large variable threads and a tapered core design for accurate implant placement, self tapping, improved aesthetics and better load distribution.

Touareg™ S Implants have a specially designed domed apex helps reduce the risk of perforation of the sinus membrane while achieving optimal initial stability. The unique design of the Touareg™ S allows for immediate loading in all bone types.



£99.00

Touareg™ S Implants



3.50mm Diameter

Length	6.25mm	8mm	10mm	11.5mm	13mm	16mm	18mm
Mounted	n/a	ISPS0835	ISPS1035	ISPS1135	ISPS1335	ISPS1635	ISPS1835
Unmounted	n/a	UISPS0835	UISPS1035	UISPS1135	UISPS1335	UISPS1635	UISPS1835



3.75mm Diameter

Length	6.25mm	8mm	10mm	11.5mm	13mm	16mm	18mm
Mounted	n/a	ISPS0838	ISPS1038	ISPS1138	ISPS1338	ISPS1638	ISPS1838
Unmounted	n/a	UISPS0838	UISPS1038	UISPS1138	UISPS1338	UISPS1638	UISPS1838



4.20mm Diameter

Length	6.25mm	8mm	10mm	11.5mm	13mm	16mm	18mm
Mounted	ISPS0642	ISPS0842	ISPS1042	ISPS1142	ISPS1342	ISPS1642	ISPS1842
Unmounted	UISPS0642	UISPS0842	UISPS1042	UISPS1142	UISPS1342	UISPS1642	UISPS1842



5.00mm Diameter

Length	6.25mm	8mm	10mm	11.5mm	13mm	16mm	18mm
Mounted	ISPS0650	ISPS0850	ISPS1050	ISPS1150	ISPS1350	ISPS1650	ISPS1850
Unmounted	UISPS0650	UISPS0850	UISPS1050	UISPS1150	UISPS1350	UISPS1650	UISPS1850



6.00mm Diameter

Length	6.25mm	8mm	10mm	11.5mm	13mm	16mm	18mm
Mounted	ISPS0660	ISPS0860	ISPS1060	ISPS1160	ISPS1360	n/a	n/a
Unmounted	n/a	n/a	n/a	n/a	n/a	n/a	n/a

Touareg implants are available in Unmounted without an implant carrier or a Mounted implant presented on an implant carrier.

The mount should only be used to position the implant into the osteotomy and screw in a few turns, until secure in the bone. The carrier should then be removed by directly pulling back and switch to a surgical driver to fully seat the implant.

Healing Abutments

£20.00

Slim	3.5mm Diameter	
	RS3027	2mm Gingival Height
	RS3028	3mm Gingival Height
	RS3029	4mm Gingival Height
	RS3030	5mm Gingival Height
	RS3031	6mm Gingival Height
Standard	4.5mm Diameter	
	RS3022	2mm Gingival Height
	RS3023	3mm Gingival Height
	RS3024	4mm Gingival Height
	RS3025	5mm Gingival Height
	RS3026	6mm Gingival Height
Anatomical	6.0mm Diameter	
	RS3012	2mm Gingival Height
	RS3013	3mm Gingival Height
	RS3014	4mm Gingival Height
	RS3015	5mm Gingival Height

Temporary Abutments

	RS3411	2mm Straight Cylindrical Engaging Ø 4.5mm RH 8mm	£24.00
	RS3422	2mm Straight Cylindrical Non Engaging Ø 4.5mm RH 8mm	£24.00
	RS4900	TMA Temporary Copying Ø n/a RH 12mm	£37.00

NOTE

Plastic Titanium casting abutments require special instruction for use. Literature on melting points and metal to use available upon request.

Transfers / Impression Copings

£28.00

Fixture Level		Ø	Length
	RS3510	Slim Open Tray	3.6mm 10mm
	RS3514	Slim Open Tray	3.6mm 14mm
	RS4510	Wide Open Tray	4.5mm 10mm
	RS4514	Wide Open Tray	4.5mm 14mm
	RS5109	Slim Closed Tray	3.5mm 9mm
	RS5113	Slim Closed Tray	3.5mm 13mm
	RS5509	Slim Closed Tray	3.5mm 9mm
	RS5512	Slim Closed Tray	3.5mm 12mm
	RS5209	Wide Closed Tray	4.5mm 9mm
	RS5213	Wide Closed Tray	4.5mm 13mm
	RS5600	Wide Closed Tray	5.5mm

Screw/Casting Abutments

	RS3090	Plastic/Gold Casting Engaging Ø 0.5mm GH 3.9mm	£135.00
	RS3094	Plastic/Chrome Engaging Ø 3.9mm GH 0.5mm L 12.1mm	£60.00
	RS3100	Plastic/Chrome Non Engaging Ø 3.9mm GH 0.5mm L 12.1mm	£56.90
	RS5000	Plastic Cylindrical Casting Engaging Ø 0.5mm GH 3.9mm	£23.00
	RS5010	Plastic Stand Casting Engaging Ø 4.5mm GH 0mm	£23.00
	RS5020	Plastic Cylindrical Casting Non Engaging Ø 3.85mm GH 0.5mm	£23.00
	RS5030	Plastic Standard Engaging Ø 4.5mm GH 2.0mm	£23.00
	RS5040	Plastic Cylindrical Engaging Ø 3.85mm GH 0mm	£23.00
	RS5050	Plastic Standard Non Engaging Ø 4.55mm GH 1.0mm	£23.00
	RS5001	Plastic Casting Sleeve Ø 4.85mm RH 12mm	£26.00
	RS3095	Plastic/Titanium Engaging Ø 1.4mm GH 4.9mm ⓘ	£24.00
	RS3097	Plastic/Titanium Non Engaging Ø 1.4mm GH 4.9mm ⓘ	£24.00

Snap-on Iris™

Adin's Snap-on impression is an effective and easy option for both implant level and abutment level impression copying. Plastic pickup cap placed over a precision machined abutment allows for accurate coping utilising closed tray impression.

Adin's Snap-on range aims to allow flexibility by offering various options to match users preferred method of use through pre packed kits.

Snap-on
Impression Coping

Snap-on
engagement

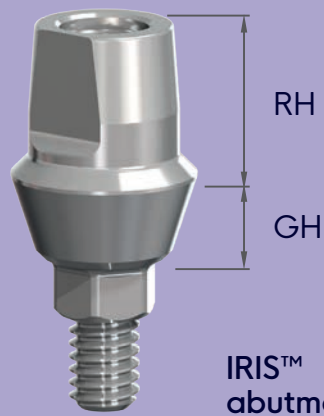
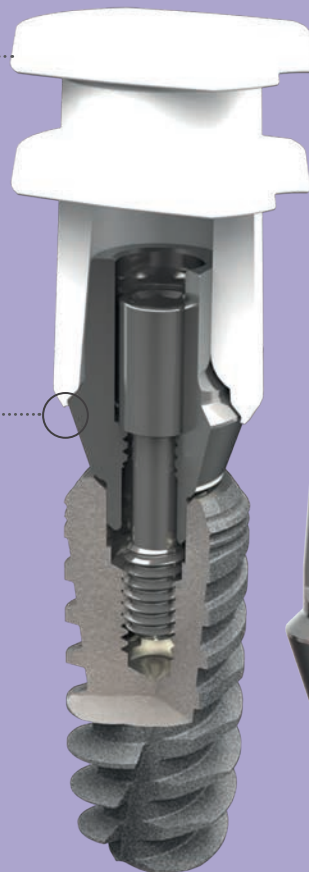

IRIS™
abutment



Snap-on Impression Kit includes:

1 x IRIS™ Abutment | 1 x Snap-on Cap | 1 x Implant Analog



Snap-on Impression Kit for Touareg S / OS™ Implants

The Snap-on impression kit is an easy to use implant level closed tray coping option. The variety in abutment transfer heights allows the taking of accurate impression in situations when other impression options do not.



Touareg S™ / OS™ £30.00

		RH	GH
IR4141	RS Touareg Snap-on Impression Kit	4	1
IR4142	RS Touareg Snap-on Impression Kit	4	2
IR4143	RS Touareg Snap-on Impression Kit	4	3
IR4144	RS Touareg Snap-on Impression Kit	4	4

Single item range for Touareg S / OS™ Implants

Understanding that set procedures are not for everyone and in an effort to allow for full flexibility for Adin users, items are also available in single form.

Abutment Replica £24.00

		RH
	IR0404 IRIS Abutment Replica	4
	IR0406 IRIS Abutment Replica	6
	IR0408 IRIS Abutment Replica	8

Comfort Cap £16.00

		RH
	IR0180 IRIS PEEK Comfort Cap	4
	IR0181 IRIS PEEK Comfort Cap	6
	IR0089 IRIS PEEK Comfort Cap	8



Burnout Sleeves £24.00

	IR0182 IRIS Burnout Anti-rotation Cap, Red
	IR0183 IRIS Burnout Free-rotation Cap, White

Snap-on Impression Cap £40.00



	IR0179 IRIS Impression Coping
---	-------------------------------

Cement Abutment Straight £24.00

Slim Diameter 3.9mm		RH	GH
	RS3903	3mm	No Shoulder 0.65mm
	RS3906	6mm	No Shoulder 0.65mm
	RS3908	8mm	No Shoulder 0.65mm

Standard Diameter 4.5mm		RH	GH
	RS3800	7.5mm	No Shoulder
	RS3801	7.6mm	1mm Shoulder
	RS3802	7.6mm	2mm Shoulder
	RS3803	7.6mm	3mm Shoulder
	RS3804	7.6mm	4mm Shoulder
	RS3805	7.6mm	5mm Shoulder
	RS3811	11mm	1.5 Long

Cement Abutment Straight £30.00

Aesthetic Diameter 4.5mm		RH	GH
	RS0010	6.5mm	1mm Shoulder
	RS0011	6.5mm	2mm Shoulder
	RS0012	6.5mm	3mm Shoulder

Wide Diameter 5.0mm		RH	GH
	RS3950	7.35mm	No Shoulder

Wide Diameter 4.5mm		RH	GH
	RS3890	6.9mm	Preppable

Cement Abutment Angled 15° £30.00

Standard Diameter 4.7mm		RH	GH
	RS4015	7.0mm	Standard 1.6mm
Standard Diameter 4.8mm		RH	GH
	RS4016	10.0mm	Long 1.4mm

Cement Abutment Angled 15° £37.00

Slim No End Line Diameter 3.8mm		RH	GH
	RS4017	7.36mm	1mm High
	RS4018	7.36mm	2mm High
	RS4019	7.36mm	3mm High

Aesthetic Diameter 4.7mm		RH	GH
	RS4115	7.36mm	1mm Shoulder
	RS4117	7.36mm	2mm Shoulder
	RS4119	7.36mm	3mm Shoulder

Cement Abutment Angled 25° £30.00

Standard Diameter 5.0mm		RH	GH
	RS4025	7.0mm	1.8mm

Cement Abutment Angled 35° £46.00

Standard Diameter 4.8mm		RH	GH
	RS4035	8.0mm	1.8mm

Cement Abutment One Piece £24.00

	RS3812	One Piece Screw In No Hex	
---	--------	---------------------------	--

Ball Abutments £24.00

Ball Diameter 2.5mm		RH	GH
	RS2861	2.72mm	1mm collar height
	RS2862	2.72mm	2mm collar height
	RS2863	2.72mm	3mm collar height
	RS2864	2.72mm	4mm collar height
	RS2865	2.72mm	5mm collar height
	RS2866	2.72mm	6mm collar height

IMPORTANT

The Restorative Torque Driver RS6090 is needed to fit all ball attachments (page 14). This driver is not included in any surgical kits. When ordering ball abutments you will also need to order ball attachment caps and inserts featured below.



Ball Abutment Caps & Inserts

	RS2660	Plastic Insert White Hard	£10.00
	RS2662	Plastic Insert Pink Soft	£10.00
	RS2670	Titanium Ball Keeper	£37.00



Implant Analogues

	RS5737	Internal Hex	£19.00
	RS5740	Ball Abutment	£24.00
	RS5004	TMA Abutment Analogue	£24.00

Surgical Drivers £54.00

For use with mounted and unmounted implants

Implant

	RS9021	Short
	RS9026	Medium
	RS9029	Long





Adapters £57.60

Converts Surgical Implant Drivers above to Torque Driver Tip







Wrench Ratchet Surgical Instrument Handle RA0050

Restorative Hand Drivers £54.00

	RS6095	Hex 1.27mm Short 8mm
	RS6094	Hex 1.27mm Medium 14mm
	RS6097	Hex 1.27mm Long 33mm
	RS6191	TMA/FC Long Female Hex
	RS6193	TMA/FC Short Female Hex

Restorative RA Drivers**£54.00**

	RS9035	Hex 1.27mm Long
	RS9030	Hex 1.27mm Short
	RS6194	TMA/FC Short Female Hex
	RS6195	TMA/FC Long Female Hex

Restorative Torque Drivers**£54.00**

	RS6080	Hex 1.27mm Short 10mm
	RS6082	Hex 1.27mm Long 15mm
	RS6090	Ball Attachment
	RS6197	TMA/FC Hex Short
	RS6196	TMA/FC Hex Long

Abutment Screws

	RS3400	Prosthetic Straight	£7.00
	RS3480	Angled	£7.00

TMA Screws

	RS3404	TMA Prosthetic	£7.00
	RS3406	TMA 1mm	£5.00
	RS3407	TMA 2mm	£5.00
	RS3408	TMA 3mm	£5.00
	RS3409	TMA 4mm	£10.50
	RS3412	TMA 5mm	£10.50
	RS3403	TMA Angled	£10.50

Accuracy & flexibility for single tooth restoration

STMA offers the possibility to combine the benefits of trans-gingival approach and screw-retained single tooth restoration yielding greater flexibility in both esthetics, safety and restoration maintenance.

Based on the TMA abutment, with the added hex index offers both the required accurate positioning and retention to support a single tooth crown. Open and closed tray transfers as well as scan bodies for digital impression are available to match every preferred impression method as well as replicas for straight forward and simple work processes.

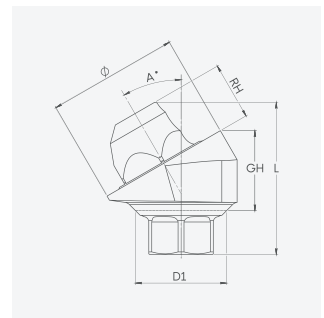
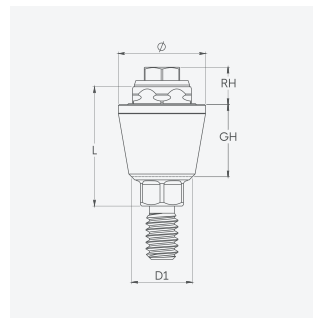

TMA Straight Single

£49.00

RS		L	D1	Ø	GH	RH
RS3731S	STMA Abutment 1mm	3.7	3.4	4.9	1.0	2.1
RS3732S	STMA Abutment 2mm	4.7	3.4	4.9	2.0	2.1
RS3733S	STMA Abutment 3mm	5.7	3.4	4.9	3.0	2.1
RS3729S	STMA Abutment 4mm	6.7	3.4	4.9	4.0	2.1
RS3730S	STMA Abutment 5mm	7.7	3.4	4.9	5.0	2.1



TMA Angled Single

£79.00

RS		L	D1	Ø	GH	RH
RS3734S	STMA Abutment 17° 2mm	5.2	3.4	4.9	2.0	2.15
RS3735S	STMA Abutment 30° 3mm	5.7	3.4	4.9	3.0	2.15
RS3737S	STMA Abutment 17° 3mm	6.2	3.4	4.9	3.0	2.15
RS3738S	STMA Abutment 30° 4mm	6.5	3.4	4.9	4.0	2.15

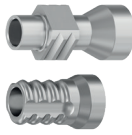
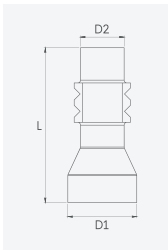

**Transfers**

		L	D1	D2	
RS5006S	Single TMA Open Tray Transfer	11.0	4.9	3.1	£49.00
RS5011S	Single TMA Closed Tray Transfer	8.0	4.9	4.1	£44.50

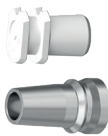
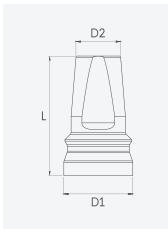
**Snap-On**

		L	D1	D2	
IR0179	IRIS™, Impression coping				£40.00
RS5012S	Single TMA Snap-On Transfer	8.0	4.9	3.2	£49.00

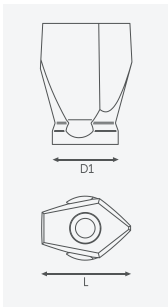
**Scan Body**

		L	D1	
TM0006S	Single TMA Scan Body	6.0	4.9	£40.50
TM0009S		9.0	4.9	£40.50

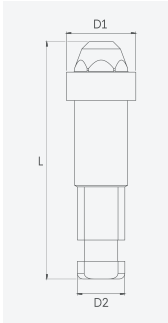
**STMA Replica**

		L	D1	
RS5004S	STMA Abutment Replica	16.75	4.9	£24.10

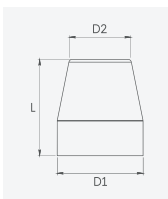
**Healing Cap**

		L	D1	D2	
RS5005S	Single TMA Healing Cap	5.5	4.9	3.5	£24.10

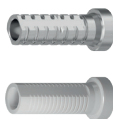
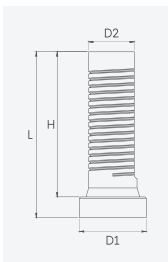
**STMA Prosthetic**

		L	D1	D2	H	
RS4900S	Single TMA Titanium Temporary	12.0	4.9	3.5	10.5	£37.00
RS5001S	Single TMA Plastic Casting Sleeve with Prosthetic Screw	12.0	4.9	3.5	10.35	£26.00

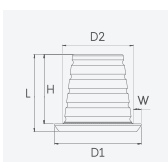
**STMA Prosthetic**

		L	D1	D2	H	W	
TM0011S	Single TMA Cementing Cone, Low profile	4.9	5.5	4.5	4.4	0.5	£38.10







TMA Multi-Unit Abutments

Trans Mucosal Abutments to facilitate All-on-4 and All-on-6 implant restorations.

Replacement screws for components are available.

TMA Screw Retained Straight £49.00

Diameter 4.9mm		RH	GH
	RS3731	1.0 mm	1mm
	RS3732	1.0 mm	2mm
	RS3733	1.0 mm	3mm
	RS3729	1.0 mm	4mm
	RS3730	1.0 mm	5mm



TMA Screw Retained Angled £79.00

Diameter 4.9mm		RH	GH
	17° RS3734	2.15mm	2mm
	17° RS3737	2.15mm	3mm
	30° RS3735	2.15mm	3mm
	30° RS3738	2.15mm	4mm
	45° RS3736	2.15mm	4mm

TMA Accessories

	RS4900	Temporary Copying Ø 4.85mm RH 12mm	£37.00
	RS5001	Plastic Casting Sleeve Ø 4.85mm RH 12mm	£26.00
	RS5004	Abutment Analogue	£24.00
	RS5005	Healing Cap	£24.00
	RS5006	Open Tray Transfer Ø 4.9mm RH 11mm	£44.00
	RS5011	Closed Tray Transfer	£44.00

TMA Hand Drivers ⓘ £54.00

	RS6191	Female Long Hex
	RS6193	Female Short Hex

TMA Torque Drivers ⓘ £54.00

	RS6196	TMA/FC Hex Long
	RS6197	TMA/FC Hex Short

TMA RA Drivers ⓘ £54.00

	RS6195	TMA/FC Hex Long
	RS6194	TMA/FC Hex Short

ⓘ NOTE

Use TMA Drivers for Straight TMA Abutments, and a Hex 1.27 Driver for Angled TMA Abutments [RS6082]



Premium Surgical Kit

RS6301

£1,150.00

Drills

Tip Drill	RS8032
Tri-Step Drill - Long	TD2218
Pilot Drill 2mmD x 8 - 18mmL	DL1820
Twist Step Drill 2.3 / 2.8mmD x 8 - 18mmL	DL1828
Twist Step Drill 2.8 / 3.2mmD x 8 - 18mmL	DL1832
Twist Step Drill 3.2 / 3.6mmD x 8 - 18mmL	DL1836
Twist Step Drill 3.8 / 4.2mmD x 8 - 18mmL	DL1842
Twist Step Drill 4.2 / 4.6mmD x 8 - 18mmL	DL1846
Twist Step Drill 4.8 / 5.2mmD x 8 - 18mmL	DL1852
Twist Step Drill 5.2 / 5.6mmD x 8 - 18mmL*	DL1856
Tri-Step Drill - Short	TD1511
Pilot Drill 2mmD x 6 - 13mmL	DL1320
Twist Step Drill 2.3 / 2.8mmD x 6 - 13mmL	DL1328
Twist Step Drill 2.8 / 3.2mmD x 6 - 13mmL	DL1332
Twist Step Drill 3.2 / 3.6mmD x 6 - 13mmL	DL1336
Twist Step Drill 3.8 / 4.2mmD x 6 - 13mmL	DL1342
Twist Step Drill 4.2 / 4.6mmD x 6 - 13mmL	DL1346
Twist Step Drill 4.8 / 5.2mmD x 6 - 13mmL	DL1352
Twist Step Drill 5.2 / 5.6mmD x 6 - 13mmL	DL1356

Surgical Tools

Wrench Ratchet Surgical Instruments Handle	RA0050
Surgical Torque Ratchet 35 - 100 Ncm	RS6111
Depth Probe	RS6180

Parallel Pins

Parallel Pin Short 11mm (qty. 4)	RS6150
Parallel Pin Long 16mm (qty. 2)	RS6155

Insertion Tools

RS Hex Handpiece Adapter - Short	RS9021
RS Hex Handpiece Adapter - Medium	RS9026
RS Hex Handpiece Adapter - Long	RS9029

Drivers

1.27 Hex Hand Driver - Short	RS6095
1.27 Hex Hand Driver - Medium	RS6094

Drill Extension

Drill Extension	RS9027
-----------------	--------

*Products may be ordered separately as an addition to the kit



Advanced Surgical Kit

RS6322

£770.00

Drills

Pilot Drill 2mmD x 8 - 18mmL	DL1820
Twist Step Drill 2.3 / 2.8mmD x 8 - 18mmL	DL1828
Twist Step Drill 2.8 / 3.2mmD x 8 - 18mmL	DL1832
Twist Step Drill 3.2 / 3.6mmD x 8 - 18mmL	DL1836
Twist Step Drill 3.6 / 4.2mmD x 8 - 18mmL	DL1842
Twist Step Drill 4.2 / 4.6mmD x 8 - 18mmL	DL1846

Surgical Tools

Wrench Ratchet Surgical Instruments Handle	RA0050
Surgical Torque Ratchet 35 - 100 Ncm	RS6111
Depth Probe	RS6180

Parallel Pins

Parallel Pin Short 11mm (qty. 4)	RS6150
Parallel Pin Long 16mm (qty. 2)	RS6155

Insertion Tools

RS Hex Handpiece Adapter - Short	RS9021
RS Hex Handpiece Adapter - Medium	RS9026
RS Hex Handpiece Adapter - Long	RS9029

Drivers

1.27 Hex Hand Driver - Short	RS6095
1.27 Hex Hand Driver - Medium	RS6094

Drill Extension

Drill Extension	RS9027
-----------------	--------

Trycare Basic Prosthetic Kit

£531.80

	RS6080	Restorative Torque Driver Hex 1.27mm Short 10mm
	RS6082	Restorative Torque Driver Hex 1.27mm Long 15mm
	RS6197	Restorative Torque Driver TMA/FC Hex Short
	RS6095	Restorative Hand Driver Hex 1.27mm Short 8mm
	RS6097	Restorative Hand Driver Hex 1.27mm Long 33mm
	RS9030	Restorative RA Driver Hex 1.27mm Short

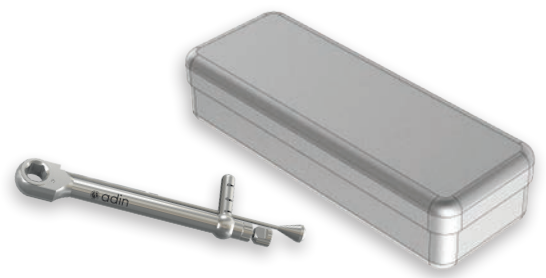

UNAB004	Aluminium Instrument Box Silver 10 x 3 x 2cm
RS6112	Prosthetic Torque Ratchet 15 - 35 Ncm



RS7001	Surgical Driver	£120.00
--------	-----------------	----------------



RS6111	Surgical Torque Ratchet 35 - 100 Ncm	£200.00
--------	--------------------------------------	----------------



RS6112	Prosthetic Torque Ratchet 15 - 35 Ncm	£200.00
--------	---------------------------------------	----------------



RS6100	Wrench Ratchet	£126.00
--------	----------------	----------------



RS6180	Depth Probe	£39.30
--------	-------------	---------------



RS6150	Parallel Pin 11	£30.00
--------	-----------------	---------------



RS6155	Parallel Pin 16	£30.00
--------	-----------------	---------------



RS8032	Tip Drill	£74.00
--------	-----------	---------------



RS9027	Drill Extender	£42.00
--------	----------------	---------------



Scanbody £36.00



RS0088 7mm

RS0089 10mm

Scanbody TMA £36.00



TM0006 6mm

TM0009 9mm

Screws £7.00



TM0001 TMA Scan Body



RS3400 RS Prosthetic



RS3425 RS Closed Tray Transfer



RS3402 RS Short Prosthetic



WP0001 WP Abutment



RP0001 RP Abutment



NP0001 NP Abutment

Ti Blanks £54.00



RS1411 Ø 11.5mm



RS1415 Ø 15.8mm

Ti Base £34.00



RS1404 Engaged



RS1417 Angular Engaged



RS1408 Non Engaged

IMPORTANT NOTE

The Screw Channel on the Angular Ti-Base is NOT angular and does NOT require an angled screwdriver.

TMA-MU



TM0010 Cementing Cone £34.00



RS4900 TMA Temporary Copying £37.00

Digital Model Analog



RS1000 RS Digital Model Analog £26.55



RS1001 Digital Model TMA Abutment Replica £30.60

CAD-CAM SOFTWARE

Scan the QR code to download the Adin CAD-CAM Software for digital libraries of Exocad, 3Shape and dental wings.



adinguide™

Take your practice to the next level

The adinguide™ was created with you in mind, bringing the guided surgery world to your clinic. The kits were specifically designed to support effortless procedures, accurate and predictable implant placement. The ActiveFlow™ Irrigation Technology is a unique design that forces coolant through the guide to ensure irrigation reaches the bone and prevents overheating.

The adinguide™ drills are designed with carved channels which allow saline coolant from your hand-piece to stream through the sleeve directly into the osteotomy site while drilling.

Our uniquely designed drill kit is intuitive and easy to use by implant diameter and length. The Tissue Punch and Pilot Drill allow for easy flapless access.

Keyless procedure enables easy handling and full visibility of surgical field.

Self-centering drills - controlled by a 5.5mm / 3.3 mm / 2.0 mm diameter cylinder at the top of each drill centers the drill in the guide's sleeve.

Self-centering cylinder - engages the sleeve before the drill engages the osteotomy in order to ensure correct positioning of the drill.

Built-in stoppers - ensure precise and accurate drilling to the desired depth.



Keyless Procedure

This innovative approach developed to support effortless procedures, accurate and predictable implant placement.



ActiveFlow™ Irrigation Technology

The adinguide™ ActiveFlow™ Irrigation Technology is a unique design that forces coolant through the guide and ensure that irrigation reaches the bone. Within each cylinder are unique channels which allow coolant to stream through the sleeve while drilling.

- ActiveFlow™ Technology- through the guide irrigation
- As the drill starts to spin, ActiveFlow™ starts operation
- Delivers the coolant from the hand- piece directly to the surgical site and may prevent bone heating

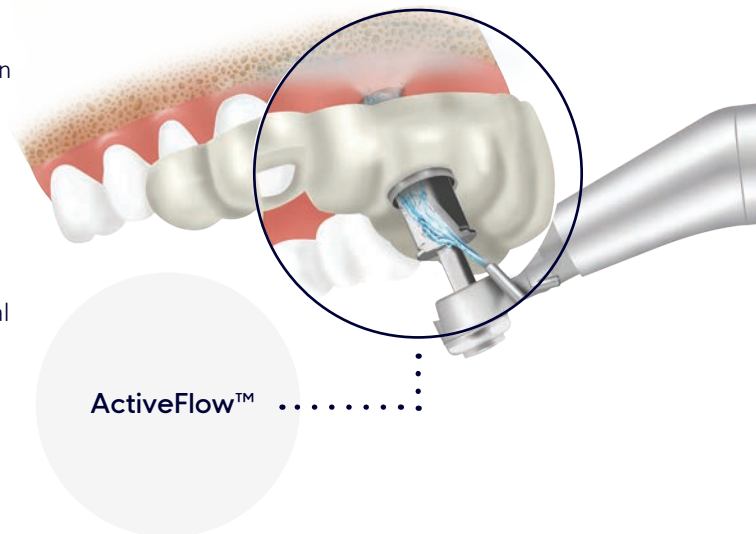

Self-Centering Drills & Tools

Adin's keyless, self- centering drills and tools are designed to enable dentists to perform faster, easier and more intuitive implant surgeries. Organized in a way that enhances safety and ease of use, Adin sleeves are embedded within the 3D printed surgical guide and precisely center and guide drills and insertion tools. Self- centering drills, controlled by a main diameter cylinder at the top of each drill, centers the drill in the guide's sleeve. The surgical guide and drilling procedure are designed so that the self-centering cylinder engages the sleeve before the drill touches the bone in order to ensure correct positioning of the drill.

.....

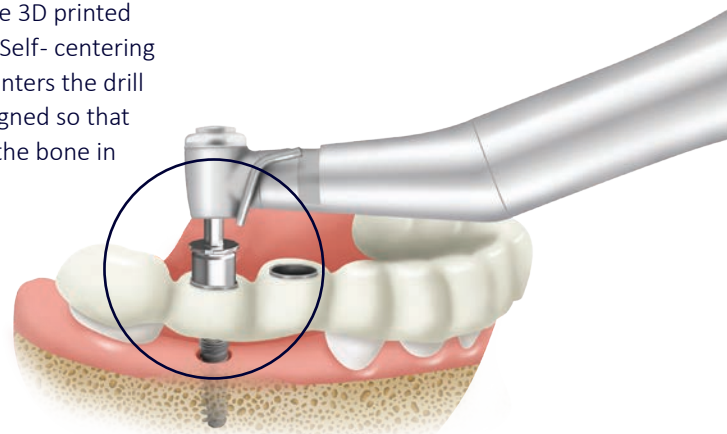



Buy both kits together

RS Touareg™ Implants Drill Kit

GSK001

£1,300.00

	Tissue Punch 5.0mmD, S-5.5	GS5055		Drill S-5.5, 3.85 / 3.2mmD x 6.25mmL	GS0638
	Pilot Drill S-5.5, 2.5 / 1.8mmD x 6.0mmL	GS0625		Drill S-5.5, 3.85 / 3.2mmD x 8.0mmL	GS0838
	Drill S-5.5, 2.5 / 1.8mmD x 8.0mmL	GS0825		Drill S-5.5, 3.85 / 3.2mmD x 10.0mmL	GS1038
	Drill S-5.5, 2.5 / 1.8mmD x 10.0mmL	GS1025		Drill S-5.5, 3.85 / 3.2mmD x 11.5mmL	GS1138
	Drill S-5.5, 2.5 / 1.8mmD x 11.5mmL	GS1125		Drill S-5.5, 3.85 / 3.2mmD x 13.0mmL	GS1338
	Drill S-5.5, 2.5 / 1.8mmD x 13.0mmL	GS1325		Drill S-5.5, 3.85 / 3.2mmD x 16.0mmL	GS1638
	Drill S-5.5, 2.5 / 1.8mmD x 16.0mmL	GS1625		Drill S-5.5, 4.6 / 3.85mmD x 6.25mmL	GS0646
	Drill S-5.5, 3.2 / 2.5mmD x 6.25mmL	GS0632		Drill S-5.5, 4.6 / 3.85mmD x 8.0mmL	GS0846
	Drill S-5.5, 3.2 / 2.5mmD x 8.0mmL	GS0832		Drill S-5.5, 4.6 / 3.85mmD x 10.0mmL	GS1046
	Drill S-5.5, 3.2 / 2.5mmD x 10.0mmL	GS1032		Drill S-5.5, 4.6 / 3.85mmD x 11.5mmL	GS1146
	Drill S-5.5, 3.2 / 2.5mmD x 11.5mmL	GS1132		Drill S-5.5, 4.6 / 3.85mmD x 13.0mmL	GS1346
	Drill S-5.5, 3.2 / 2.5mmD x 13.0mmL	GS1332		Drill S-5.5, 4.6 / 3.85mmD x 16.0mmL	GS1646
	Drill S-5.5, 3.2 / 2.5mmD x 16.0mmL	GS1632			

*Products may be ordered separately as an addition to the kit

for only
£1,995.00



RS Touareg™ Implants Tool Kit

GSK003

£900.00

	RS Handpiece Fixture Mount	GS0032		RS Extraction Tool	GS0035
	RS Grip Fixture Mount	GS0034		1.27 Hex Hand Driver - Medium	RS6094
	RS Screw Fixture Mount (qty 4)	GS0029		Manual Socket L 10.5	GS0023
	Anchoring Drill S-2.0, 2.0 / 1.7mmD x 19mmL	GS1917		Manual Socket L 14.5	GS0024
	Anchoring Drill S-2.0, 2.0 / 1.5mmD x 19mmL	GS1915		Handpiece Socket L 10.5	GS0021
	Handpiece Guide Fixation Screw Driver	GS0028		Drill Extension	RS9027
	Surgical Torque Ratchet 35 - 100 Ncm for hex 4mm	GS6111			
	Guide Fixation Screw Driver	GS0027			

Sleeves

£10.50



GS0055 5.5mmD Sleeve

GS0033 Narrow Implants 3.3mmD Sleeve

GS1920 2.0mmD Sleeve

Screws

£8.20



GS1920 2.0D 19mmL Anchorage Screw



GS0006 Vertical Fixation Screw S-3.3



GS0007 Vertical Fixation Screw S-5.5

Drills 18mm

£8.20



GS1825 Drill S-5.5, 2.5/1.8mmD x 18.0mmL



GS1832 Drill S-5.5, 3.2/2.5mmD x 18.0mmL



GS1838 Drill S-5.5, 3.85/3.2mmD x 18.0mmL



GS1846 Drill S-5.5, 4.6/3.85mmD x 18.0mmL

Drills Narrow Platform

£70.00



GSN1825 Drill S-3.3, 2.5/1.8mmD x 18.0mmL



CAD-CAM



See Adin's CAD-CAM components catalogue for a wide range of T Bases and all other components related to CAD-CAM for CloseFit™ and Touareg™ S and OS Implants. Contents of the catalogue include:

Scan Bodies - A digital transfer for intra oral scanners and other scanners.



Digital Model Analogues - For use in 3D printed models in full digital CAD-CAM solutions.



Ti Bases - A wide choice of Ti Bases to restore an implant using digital CAD-CAM solutions.

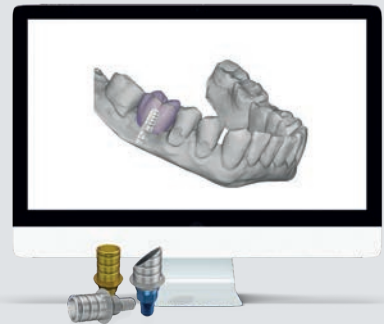

TMA Cylinders & Cementing Cones - for use on TMA (Trans Mucosal Abutments, also know as Multi Unit Abutments).

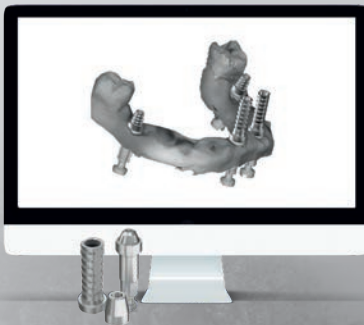

Ti Blanks - Pre-Milled Ti Blanks can be used to mill a single abutment using CAD-CAM software.

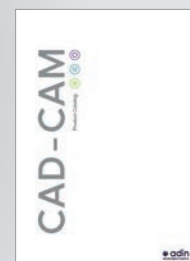
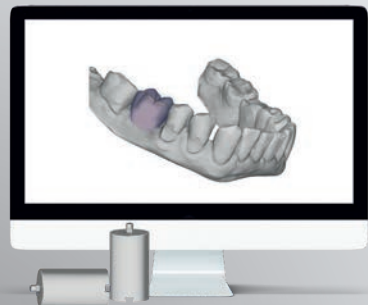

CAD-CAM Catalogue - components and digital libraries

- scan the QR code or visit www.adin-implants.com/catalog-brochures/

Tri-Step & Twist Step Surgical Drills

Adin's DLC (Diamond Like Carbon) Tri-Step/Twist Step Surgical Drills are uniquely designed and coated to improve the surgical drilling process.

Tri-Step and Twist-Step DLC drills simplify the cutting process, save time and minimise risks.

Adin's improved DLC drill coating provides state-of-the-art hardness and slickness that increases lifespan of the drill, maintains sharpness for extended drilling and generates less heat, thereby reducing chances of heating the bone or complications arising from conventional drilling protocols.

The drills come in the following diameters (mm): 2.0, 2.8, 3.2, 3.6, 4.2, 4.6, 5.2, 5.6

Specially designed for Adin's implants and suitable for their simple and convenient drilling protocol.

They are clearly and conveniently marked and can be used with or without drill stops.



Diamond Like Coating

DLC drill coating provides state-of-the-art hardness and slickness that increases lifespan of the drill, maintains sharpness for extended drilling and generates less heat, thereby reducing chances of heating the bone or complications arising from conventional drilling protocols.



£82.00

Tri-Step Drills (Three Step)

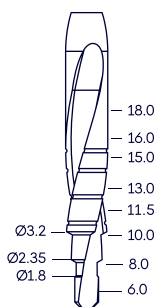

TD1511

Length

Short 15mm

Ø Diameter

1.8 - 2.35 - 3.2mm



TD2218

Long 22mm

1.8 - 2.35 - 3.2mm

Twist Step Drills (Two Step)

£91.80



short

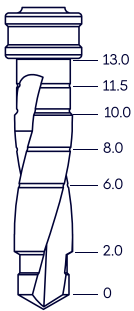

6-13mm



long

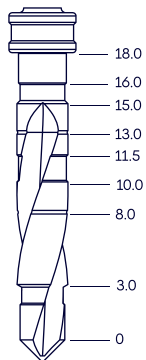

8-18mm



DL1320 Short 6 - 13mm 2.0mm Pilot White



DL1328 Short 6 - 13mm 2.3 - 2.8mm Red



DL1332 Short 6 - 13mm 2.8 - 3.2mm Blue



DL1336 Short 6 - 13mm 3.2 - 3.6mm Green



DL1342 Short 6 - 13mm 3.8 - 4.2mm Black



DL1346 Short 6 - 13mm 4.2 - 4.6mm Yellow



DL1352 Short 6 - 13mm 4.8 - 5.2mm Brown



DL1356 Short 6 - 13mm 5.2 - 5.6mm Grey



DL1820 Long 8 - 18mm 2.0mm Pilot White



DL1828 Long 8 - 18mm 2.3 - 2.8mm Red



DL1832 Long 8 - 18mm 2.8 - 3.2mm Blue



DL1836 Long 8 - 18mm 3.2 - 3.6mm Green



DL1842 Long 8 - 18mm 3.8 - 4.2mm Black



DL1846 Long 8 - 18mm 4.2 - 4.6mm Yellow



DL1852 Long 8 - 18mm 4.8 - 5.2mm Brown



DL1856 Long 8 - 18mm 5.2 - 5.6mm Grey

Drill Stop Kits

Regular Long S1001 £550.00

Regular Short S1003 £340.00

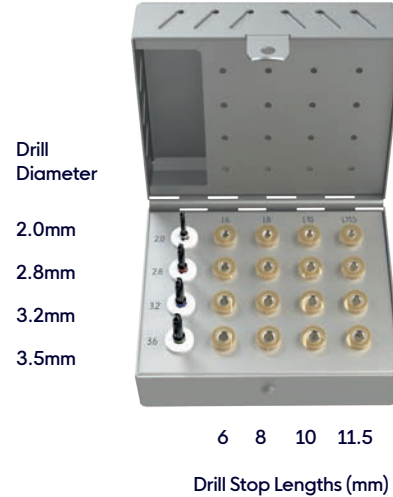
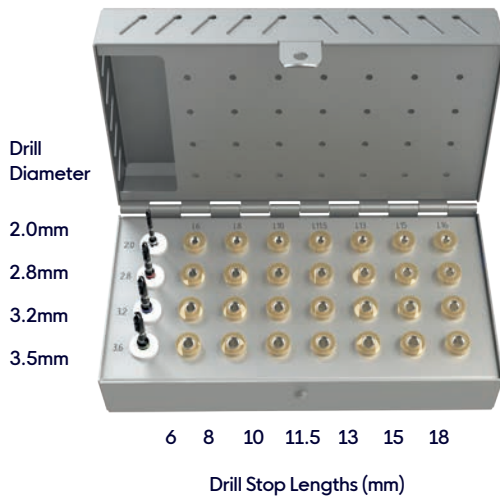

Wide Long S1002 £550.00

Wide Short S1004 £340.00

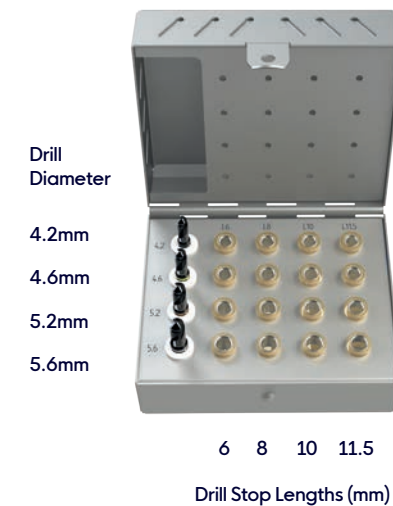
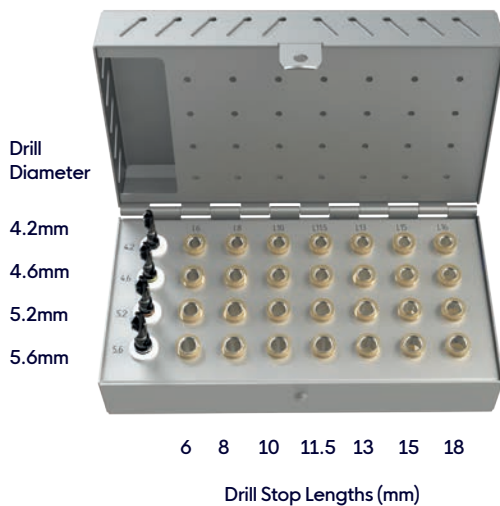

Here's how the process works:



1. Choose the drill stop that matches your drilling plan



2. Insert drill into the handpiece

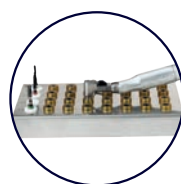

3. Insert drill into the drill stop



4. Verify your selection by examining stopper diameter and length

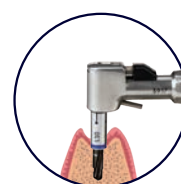

5. Perform drilling procedure



6. Manually remove stopper

Note: To have drill stops for all drill diameters, you must have both kits in long or short. All four kits are needed if you are using both long and short drills.

Implant Diameter	BONE TYPED-IV				BONE TYPED-II-III				BONE TYPED-I (Dense Bone)						
	Step	Drill Type	Drill Code		Step	Drill Type	Drill Code		Step	Drill Type	Drill Code				
			Short	Long			Short	Long			Short	Long			
3.0mm	1	Pilot	2.0	DL1320	DL1820	1	Pilot	2.0	DL1320	DL1820	1	Pilot	2.0	DL1320	DL1820
							Twist Step	2.3/2.8	DL1328	DL1828			Twist Step	2.3/2.8	DL1328
3.3mm	1	Pilot	2.0	DL1320	DL1820	1	Pilot	2.0	DL1320	DL1820	1	Tri-Step*	2.0	TD2218	TD1511
						2	Twist Step	(2.3/2.8)	DL1328	DL1828	2	Twist Step	(2.3/2.8)	DL1328	DL1828
3.5mm & 3.75mm	1	Tri-Step*		TD2218	TD1511	1	Tri-Step*		TD2218	TD1511	1	Tri-Step*		TD2218	TD1511
							Twist Step	(2.8/3.2)	DL1332	DL1832	2	Twist Step	(2.8/3.2)	DL1332	DL1832
4.2mm & 4.3mm	1	Tri-Step*		TD2218	TD1511	1	Tri-Step*		TD2218	TD1511	1	Tri-Step*		TD2218	TD1511
	2	Twist Step*	(3.2/3.6)	DL1336	DL1836	2	Twist Step	(3.2/3.6)	DL1336	DL1836	2	Twist Step	(3.2/3.6)	DL1336	DL1836
5.0mm	1	Tri-Step*		TD2218	TD1511	1	Tri-Step*		TD2218	TD1511	1	Tri-Step*		TD2218	TD1511
	2	Twist Step*	3.2/3.6	DL1336	DL1836	2	Twist Step	3.2/3.6	DL1336	DL1836	2	Twist Step	3.2/3.6	DL1336	DL1836
	3	Twist Step*	(3.8/4.2)	DL1342	DL1842	3	Twist Step	(3.8/4.2)	DL1342	DL1842	3	Twist Step	3.8/4.2	DL1342	DL1842
6.0mm	1	Tri-Step*		TD2218	TD1511	1	Tri-Step*		TD2218	TD1511	1	Tri-Step*		TD2218	TD1511
	2	Twist Step	3.2/3.6	DL1336	DL1836	2	Twist Step	3.2/3.6	DL1336	DL1836	2	Twist Step	3.2/3.6	DL1336	DL1836
	3	Twist Step	3.8/4.2	DL1342	DL1842	3	Twist Step	3.8/4.2	DL1342	DL1842	3	Twist Step	3.8/4.2	DL1342	DL1842
	4	Twist Step	(4.8/5.2)	DL1352	DL1852	4	Twist Step	(4.8/5.2)	DL1352	DL1852	4	Twist Step	4.8/5.2	DL1352	DL1852
						5	Twist Step	(5.2/5.6)	DL1356	DL1856	5	Twist Step	5.2/5.6	DL1356	DL1856

NOTE: Drill sizes in brackets (xx/xx) denotes widening of the cortex only, not drilling to the full drilling depth.

CAUTION: The drill preparation extends up to 1mm longer than the implant. Allow for this additional length when drilling near vital anatomical structures.

***Example:** Instead of a Tri-step drill, the same result can be achieved by first using the 2mm pilot drill followed by a 2.8 and 3.2 parallel sided drill to create the step down in the osteotomy. Tri-step does the work of three drills and Twist Step the work of two. However, conventional drills can be used if preferred.

🔑 Torque for Abutment / Prosthetic Systems	CloseFit™ NP	CloseFit™ RP	CloseFit™ WP	Touareg™ S, OS, Swell
 Cover Screw	Manual 15 Ncm			
 Healing Abutments	Manual 15 Ncm			
 TMA Healing Cap	Manual 15 Ncm			
 Temporary Abutments	35 Ncm			
 Straight TMA Abutments	35 Ncm			
 Angled TMA Abutments	35 Ncm			
 Retaining Screw for TMA	15 Ncm			
 Cement Retained Titanium	35 Ncm			
 Cement Retained Zirconium	35 Ncm			
 Gold Plastic Abutments	35 Ncm			
 Ball Attachment	35 Ncm			
 Kerator Abutment	25 - 30 Ncm			
 For Implant Placement	up to 50 Ncm			



mountless

Touareg™ - S

mountless

Touareg™ - S

Dental Implant
OsseoFix™ Surface



Internal Hex



Diameter by color:

- 1.5
- 3.75
- 5



Instrument	Pilot Drill Ø 2.0mm	Twist Step Drill 2.8/3.2mm	-	Implant Placement	Cover Screw
Contra-angle Ratio	20 : 1	20 : 1	-	20 : 1	20 : 1
Maximum Torque	40 Ncm	40 Ncm	-	50 Ncm	10 Ncm
Speed	1,200 rpm	1,200 rpm	-	20 rpm	20 rpm
Rotation Direction	CW	CW	-	CW	CW
Irrigation 0 - 5	4	3	-	0	0
Recording	no	no	-	yes	no
Enable	yes	yes	-	yes	yes



NP
3.00mm
Diameter

Instrument	Tri-Step Drill	Twist Step Drill 2.8/3.2mm	-	Implant Placement	Cover Screw
Contra-angle Ratio	20 : 1	20 : 1	-	20 : 1	20 : 1
Maximum Torque	40 Ncm	40 Ncm	-	50 Ncm	10 Ncm
Speed	800 rpm	1,200 rpm	-	20 rpm	20 rpm
Rotation Direction	CW	CW	-	CW	CW
Irrigation 0 - 5	4	3	-	0	0
Recording	no	no	-	yes	no
Enable	yes	yes	-	yes	yes



RP
3.50mm
Diameter

Instrument	Tri-Step Drill	Twist Step Drill 3.2/3.6mm	-	Implant Placement	Cover Screw
Contra-angle Ratio	20 : 1	20 : 1	-	20 : 1	20 : 1
Maximum Torque	40 Ncm	40 Ncm	-	50 Ncm	10 Ncm
Speed	800 rpm	1,200 rpm	-	20 rpm	20 rpm
Rotation Direction	CW	CW	-	CW	CW
Irrigation 0 - 5	4	3	-	0	0
Recording	no	no	-	yes	no
Enable	yes	yes	-	yes	yes



WP
4.30mm
Diameter

Instrument	Tri-Step Drill	Twist Step Drill 3.2/3.6mm	Twist Step Drill 4.2/4.6mm	Implant Placement	Cover Screw
Contra-angle Ratio	20 : 1	20 : 1	20 : 1	20 : 1	20 : 1
Maximum Torque	40 Ncm	40 Ncm	40 Ncm	50 Ncm	10 Ncm
Speed	800 rpm	1,200 rpm	250 rpm	20 rpm	20 rpm
Rotation Direction	CW	CW	CW	CW	CW
Irrigation 0 - 5	4	3	3	0	0
Recording	no	no	no	yes	yes
Enable	yes	yes	yes	yes	yes



WP
5.00mm
Diameter

Instrument	Tri-Step Drill	Twist Step Drill 2.8/3.2mm	-	-	-	Implant Placement	Cover Screw
Contra-angle Ratio	20 : 1	20 : 1	-	-	-	20 : 1	20 : 1
Maximum Torque	40 Ncm	40 Ncm	-	-	-	50 Ncm	10 Ncm
Speed	800 rpm	1,200 rpm	-	-	-	20 rpm	20 rpm
Rotation Direction	CW	CW	-	-	-	CW	CW
Irrigation 0 - 5	4	3	-	-	-	0	0
Recording	no	no	-	-	-	yes	no
Enable	yes	yes	-	-	-	yes	yes



3.50mm
Diameter

Contra-angle Ratio	20 : 1	20 : 1	-	-	-	20 : 1	20 : 1
Maximum Torque	40 Ncm	40 Ncm	-	-	-	50 Ncm	10 Ncm
Speed	800 rpm	1,200 rpm	-	-	-	20 rpm	20 rpm
Rotation Direction	CW	CW	-	-	-	CW	CW
Irrigation 0 - 5	4	3	-	-	-	0	0
Recording	no	no	-	-	-	yes	no
Enable	yes	yes	-	-	-	yes	yes



3.75mm
Diameter

Instrument	Tri-Step Drill	Twist Step Drill 3.2/3.6mm	Twist Step Drill 3.8/4.2mm	Twist Step Drill 4.2/4.6mm	Twist Step Drill 4.8/5.2mm	Twist Step Drill 5.2/5.6mm	Implant Placement	Cover Screw
Contra-angle Ratio	20 : 1	20 : 1	-	-	-	-	20 : 1	20 : 1
Maximum Torque	40 Ncm	40 Ncm	-	-	-	-	50 Ncm	10 Ncm
Speed	800 rpm	1,200 rpm	-	-	-	-	20 rpm	20 rpm
Rotation Direction	CW	CW	-	-	-	-	CW	CW
Irrigation 0 - 5	4	3	-	-	-	-	0	0
Recording	no	no	-	-	-	-	yes	no
Enable	yes	yes	-	-	-	-	yes	yes



4.20mm
Diameter

Contra-angle Ratio	20 : 1	20 : 1	-	-	-	-	20 : 1	20 : 1
Maximum Torque	40 Ncm	40 Ncm	-	-	-	-	50 Ncm	10 Ncm
Speed	800 rpm	1,200 rpm	-	-	-	-	20 rpm	20 rpm
Rotation Direction	CW	CW	-	-	-	-	CW	CW
Irrigation 0 - 5	4	3	-	-	-	-	0	0
Recording	no	no	-	-	-	-	yes	yes
Enable	yes	yes	-	-	-	-	yes	yes



5.00mm
Diameter

Contra-angle Ratio	20 : 1	20 : 1	20 : 1	20 : 1	20 : 1	20 : 1	20 : 1	20 : 1
Maximum Torque	40 Ncm	40 Ncm	40 Ncm	40 Ncm	40 Ncm	40 Ncm	50 Ncm	10 Ncm
Speed	800 rpm	1,200 rpm	1,200 rpm	1,200 rpm	1,200 rpm	1,200 rpm	20 rpm	20 rpm
Rotation Direction	CW	CW	CW	CW	CW	CW	CW	CW
Irrigation 0 - 5	4	3	3	3	3	3	0	0
Recording	no	no	no	no	no	no	yes	no
Enable	yes	yes	yes	yes	yes	yes	yes	yes



6.00mm
Diameter

Kerator Overdenture Attachment System

Attachments are available for all major implant systems

Implant systems including Adin Implants, Nobel Biocare (Brånemark, Sterioss, Replace, Replace Select), 3i, Astra, ITI, Ankylos, BioHorizon, Biolok, Bicon, Camlog, Endopore, Frialit-2 & Xive, Lifecore, Zimmer (Calcitek, Paragon, Swissplus), Uniti, Pitt-Easy, Osstem, Dentium, Dio, Dentis, Megagen, Cowell Medi, Warantec **and many others!**



1

Included plastic carrier provides safer handling of the abutment. The carrier is also useful for checking the alignment angles of the implant fixtures.

6

The DUAL UNDERCUT DESIGN of the Kerator metal housing attachment provides a sturdier retention within the denture acrylic.

2

Kerator has the LOWEST VERTICAL HEIGHT of all overdenture attachment system available today.

3

DUAL RETENTION MALE allows the denture cap to gently pivot in any natural direction during occlusal while providing greater resiliency and preventing it from dislodging.

4

SELF-ALIGNING DESIGN automatically centres the male on the housing attachment prior to engagement, allowing patients to easily seat their overdenture.

5

EXTENDED RANGE MALE allows for the insertion of the overdenture with up to 40 degree of divergence between implants. 15 degree angled abutments can be used in combination to further extend the allowable divergence.



The titanium self-aligning housing that corrects divergency up to 40°

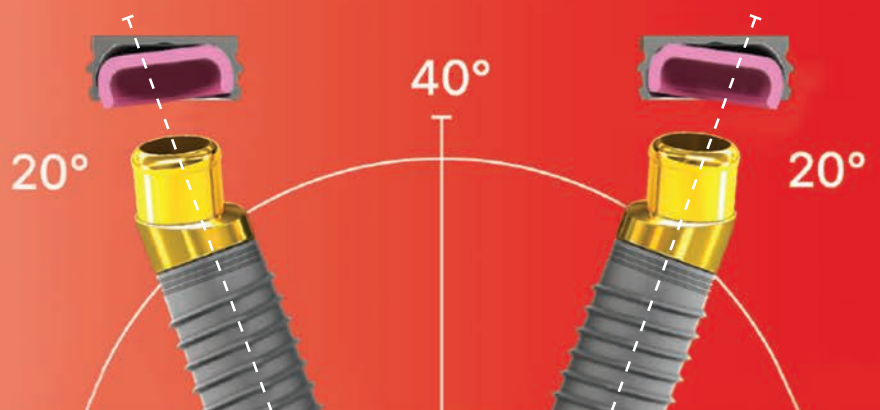

Kerator for Adin Implants

Standard* £86.00

Angled* £93.00

CloseFit™ NP 3.0mm implant		CloseFit™ RP 3.5mm implant		CloseFit™ WP 4.3 and 5.0mm implant		Touareg™ S All implant sizes	
n/a	n/a	NA350	0.0mm	NA450	0.0mm	PA350	0.0mm
AD301	1.0mm Standard	NA351	1.0mm	NA451	1.0mm	PA351	1.0mm
AD302	2.0mm	NA352	2.0mm	NA452	2.0mm	PA352	2.0mm
AD303	3.0mm	NA353	3.0mm	NA453	3.0mm	PA353	3.0mm
AD304	4.0mm	NA354	4.0mm	NA454	4.0mm	PA354	4.0mm
AD305	5.0mm	NA355	5.0mm	NA455	5.0mm	PA355	5.0mm
AD306	6.0mm	NA356	6.0mm	NA456	6.0mm	PA356	6.0mm
AD3AN1.5	1.5mm Angled	NA35AN1.5	1.5mm Angled	NA45AN1.5	1.5mm Angled	PA35AN1.5	1.5mm Angled
AD3AN3.0	3.0mm Angled	NA35AN3.0	3.0mm Angled	NA45AN3.0	3.0mm Angled	PA35AN3.0	3.0mm Angled

*Complete with denture cap and 3 inserts

Kerator Drivers and Accessories

	Tip Shape	UKLDTIP	Handpiece Driver Tip for use with <u>Straight</u> Kerator Abutments	Each	£36.30
	Tip Shape	UKTTS49	Wrench Torque Tip 4.9 Square Head for use with <u>Straight</u> Kerator Abutments	Each	£36.30
	Tip Shape	UKTTH63	Wrench Torque Tip 6.3 Hex Head for use with <u>Straight</u> Kerator Abutments	Each	£36.30
	Tip Shape	UKTTRND	Wrench Torque Tip Round Head for use with <u>Straight</u> Kerator Abutments	Each	£54.00
	Tip Shape	RS6080	Hex 1.27mm Short 10mm for use with <u>Angled</u> Kerator Abutments	Each	£54.00
	Tip Shape	RS6082	Hex 1.27mm Long 15mm for use with <u>Angled</u> Kerator Abutments	Each	£54.00
		UKMAGTL	Magic Tool for insert fitting	Each	£58.00
		UKAMH00	Metal Housing	Each	£13.00
		UKWHSR	Spacer Ring	Pack of 10	£3.60
		UKIMPCO	Kerator Impression Coping	Each	£9.60
		UKANALG	Kerator Analogue	Each	£9.60
<p>For Angled Abutments:</p> <ul style="list-style-type: none"> Red Extra Light 0.8 - 1.0 lbs Orange Light 1.8 - 2.0 lbs Green Angled 2.8 - 3.0 lbs Yellow Zero Retention 	<p>For Straight Abutments:</p> <ul style="list-style-type: none"> Blue 1.2 lbs Pink 2.4 lbs White 4 lbs Black Zero Retention 	Any Colour	Nylon Inserts	Pack of 4	£16.30

PLEASE NOTE:

For placing 'Straight Kerator Abutments' use Triangular Tipped Drivers. For placing 'Angled Kerator Abutments' use the 1.27mm Hex Tipped Driver.

NEW

Zygomatic

Touareg™ OS Dental Implants

Adin Touareg™ OS Zygomatic Dental Implants are intended for immediate loading function. Implants are placed through the maxillary arch and anchored in the zygomatic bone. The Zygomatic implant provides support for prosthetic devices such as artificial teeth in order to restore the patient's chewing function in edentulous or partially edentulous patients.

Adin Touareg™ OS Zygomatic implants are intended:

- For multi-unit reconstruction (TMA), with a rigid splinting of minimum two implants.
- For an edentulous / full mouth restoration, should be used together with at least two standard implants.
- Should be used only in patients with severe atrophic maxilla.
- Intra-maxillary sinus and extra-maxillary sinus procedures and intended to be anchored in the zygoma bone.
- One stage or two stage surgical operation.

Adin Touareg™ OS Zygomatic implants are Intended for ZAGA 0-3 cases only.

Adin Touareg™ OS Zygomatic implants are NOT Intended for ZAGA 4 cases, where implants do not pass through the maxillary alveolar bone. Immediate loading function is applicable provided that stability requirements are satisfied.

Downloads



Zygomatic Brochure - Touareg™ OS Dental Implants

- scan the QR code or visit www.adin-implants.com/catalog-brochures/

NEW

Long Implants

Implant options up to 25mm in length

Adin's long implant range serves as an extension to the current Touareg™-OS and CloseFit™ WP platform implants, allowing implant placement options up to 25mm in length.

In cases where more bone-to-implant contact is required, Long implants may serve as a solution where the space allows for longer implants, alternatively, long implants can be used effectively as bi-cortical anchorage to compensate for lack of bone while still achieving implant stability in cases where implants of regular length might not.

Adin's long implant range carry specific features designed to enhance their performance such as narrow apex for limited spaces and a smooth neck to better suite gingival engagement.

Adin's unique and reliable Osseofix™ surface treatment is utilised for both current Touareg™-OS and CloseFit™ WP platform long implants. Compatible drill set and depth probe have been designed to maximize ease of use and safety.



Long Implants Brochure - Implant options up to 25mm in length

- scan the QR code or visit www.adin-implants.com/catalog-brochures/

NEW

Single TMA

Accuracy & flexibility for single tooth restoration

Adding to Adin's verity of the screw-retained restoration range, in comes the single TMA. Utilising all the benefits of the TMA abutments while allowing the accuracy and flexibility for single tooth restoration.

Adin's STMA offer the possibility to combine the benefits of trans-gingival approach and screw-retained single tooth restoration yielding greater flexibility in both esthetics, safety and restoration maintenance.

Adin's Single TMA is based on the TMA abutment, while the added hex index offers both the required accurate positioning and retention to support a single tooth crown.

Open and closed tray transfers as well as scan bodies for digital impression are available to match every preferred impression method as well as replicas for straight forward and simple work process.



Single TMA Brochure - Accuracy & flexibility for single tooth restoration

- scan the QR code or visit www.adin-implants.com/catalog-brochures/

Dynamic. Reliable. Honest.

Trycare is grounded in innovation, service and best practice. We pride ourselves on being dynamic, reliable and most importantly of all honest! Incorporating these values into our business activities, working to provide products, services and technologies that address a variety of dental issues while rallying to the slogan "For the Dentists of tomorrow"

Discover  the magic of **Trycare**



Trycare Dental

Rialto Buildings, Station Road Clayton, Bradford BD14 6JA, UK

T. order: 01274 88 55 44, accounts: 01274 88 55 26, E. dental@trycare.co.uk, W. www.trycare.co.uk/dental